

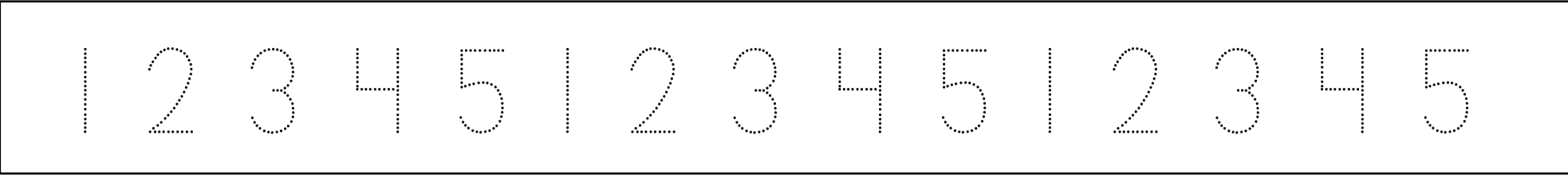

Practice tracing the numbers:

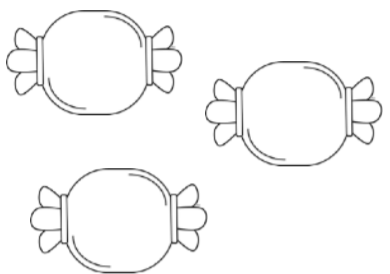
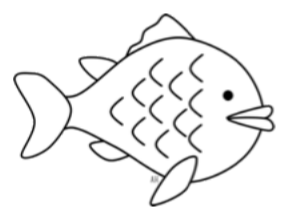
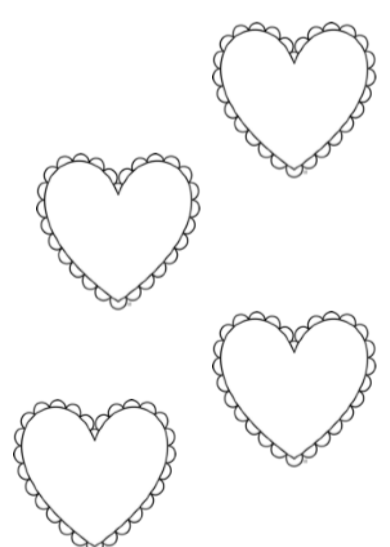

How many?

Count and Match:

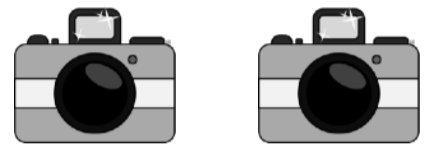
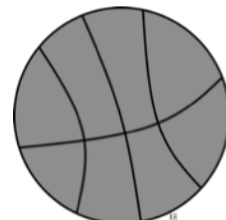
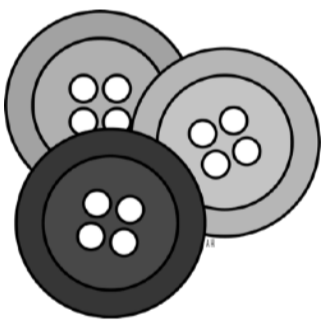
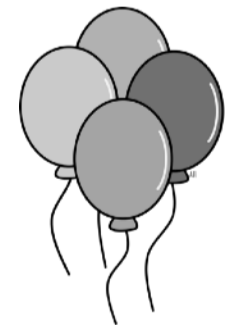

5 3 4

2 1 5

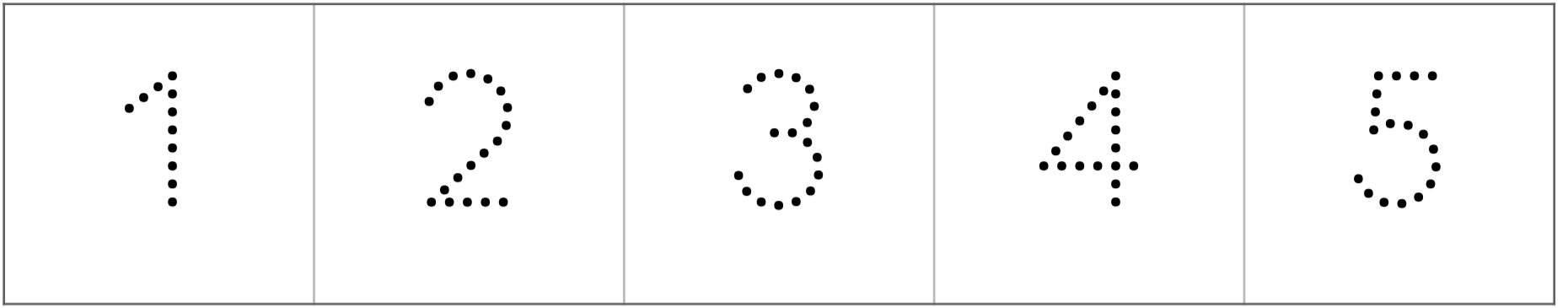
4 5 3

	5
	1
	2
	4
	3

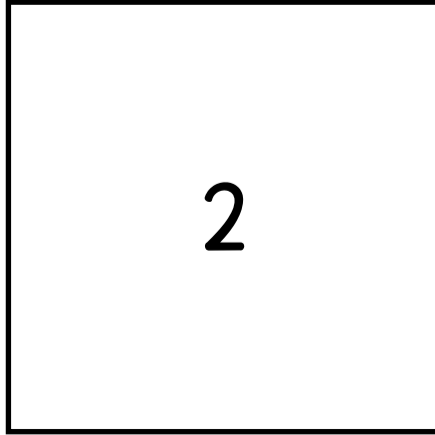
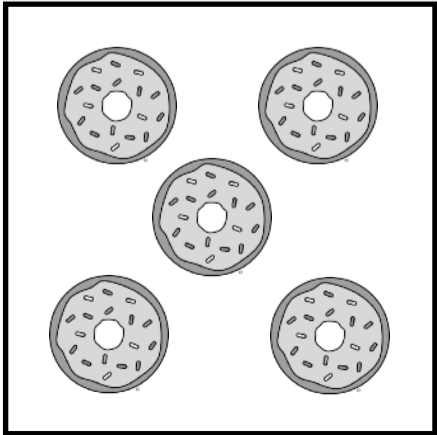
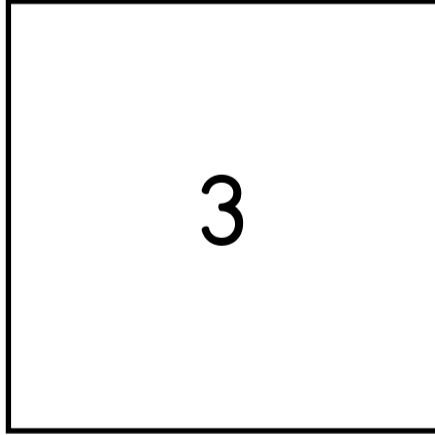
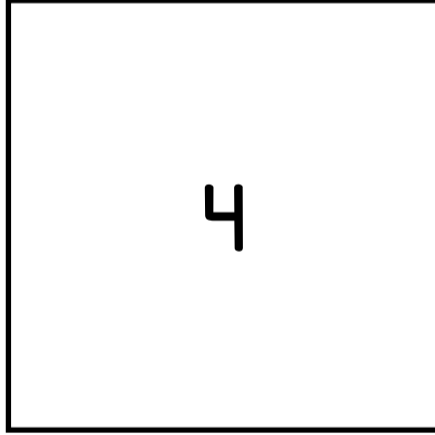
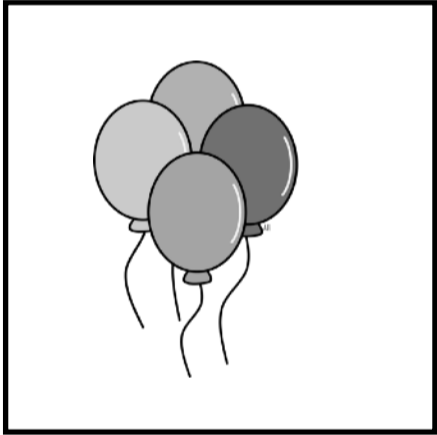
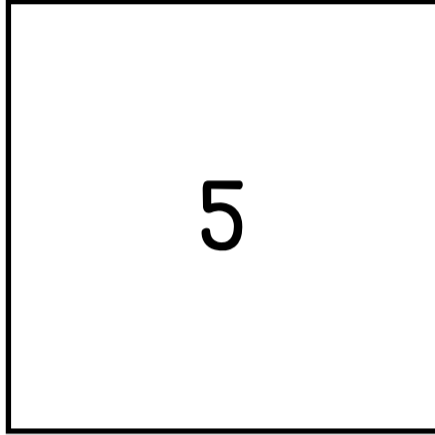
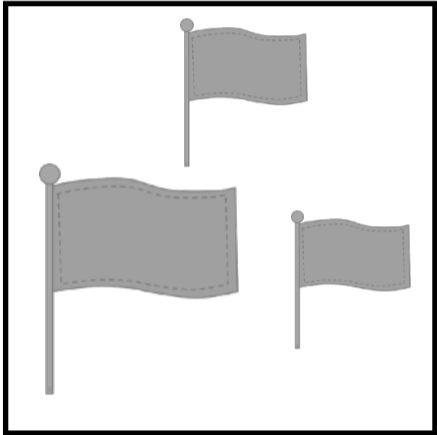
Trace the numbers:



Count and Match:



Circle all of the:

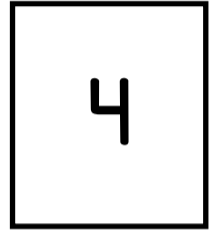

4 5 1 3

0 M 4
3 f 5 3

7 3 1

2 6 a 6

8 3 4 6

2 1 1 1

6 4 2 4

2 3 4



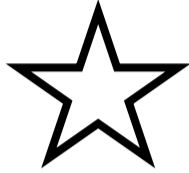
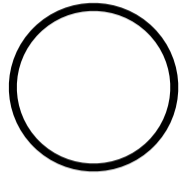
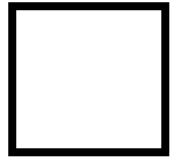

4 5 2 1

Color the correct shape:

circle



Circle the correct number of items:

	2	4
	2	1
	3	4
	2	5
	4	2

Write the numbers:





1

2

3

4

Circle the correct number of items:

	1	2
	4	5
	1	3
	5	2

Find all of the **circles**:

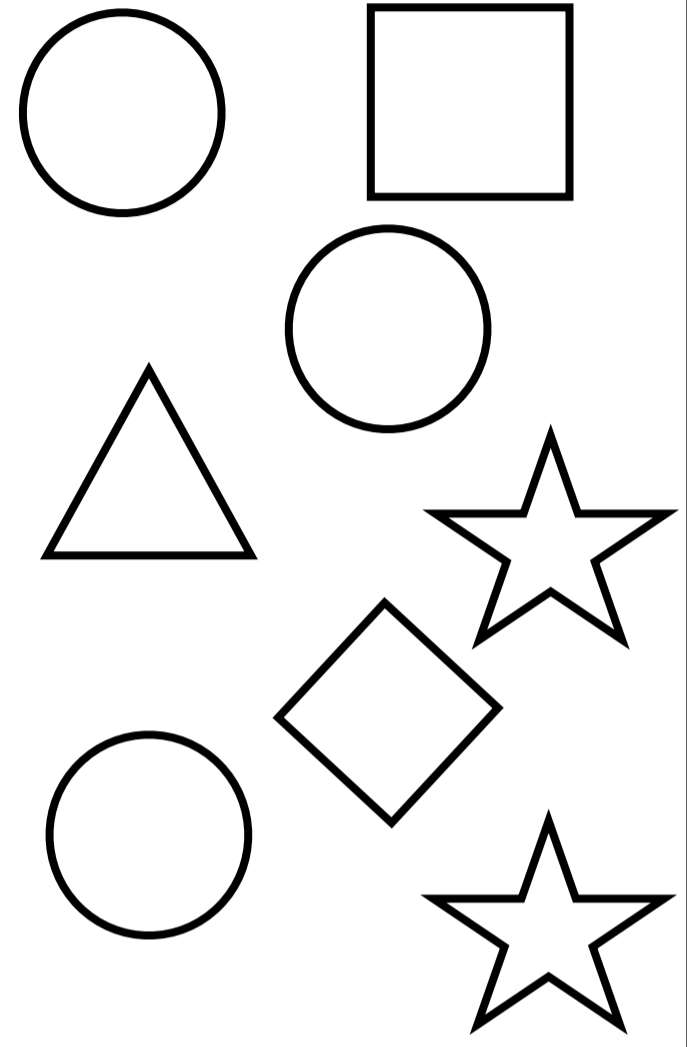

Trace the shapes:

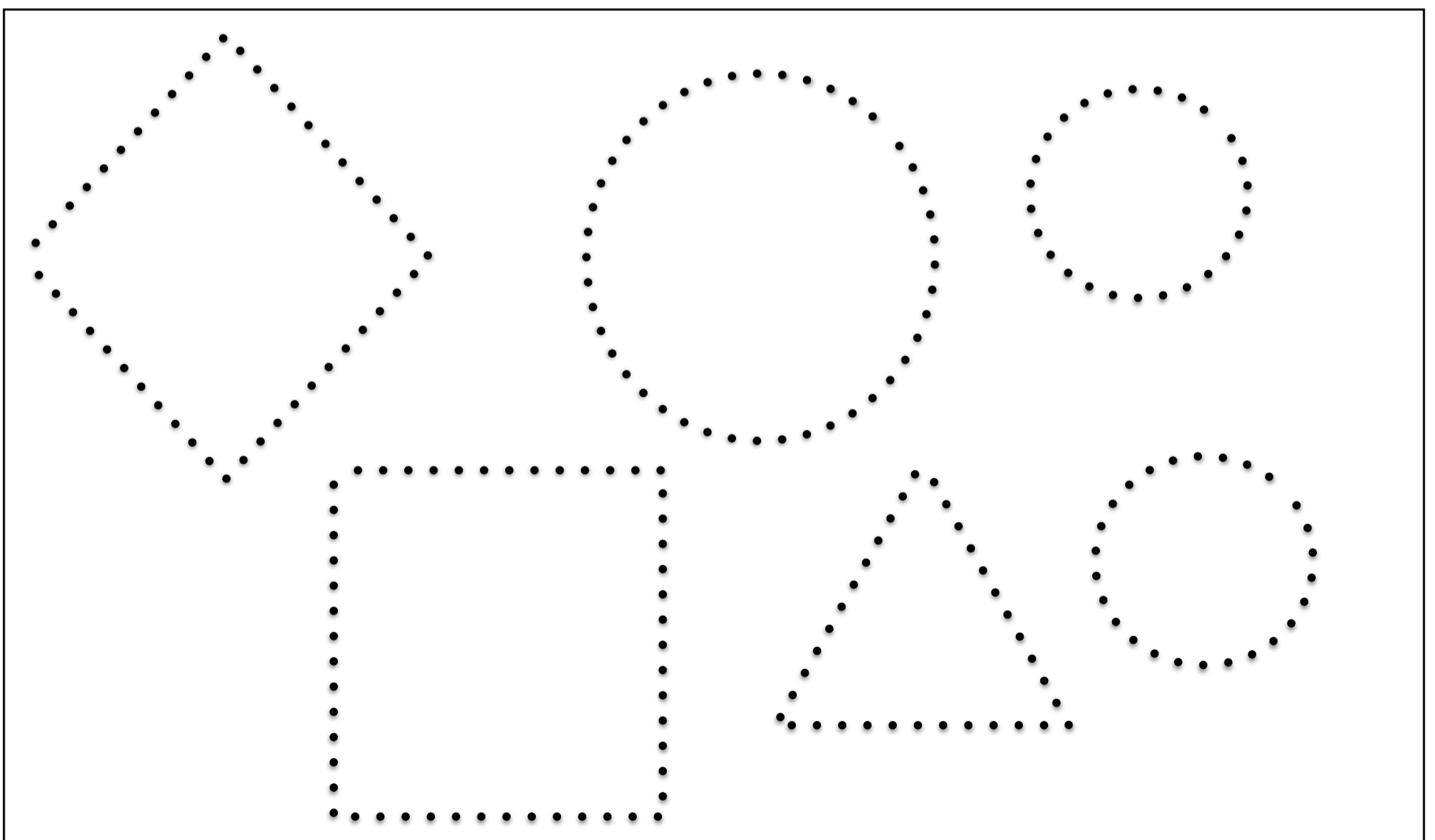

Find all of the **triangles**:

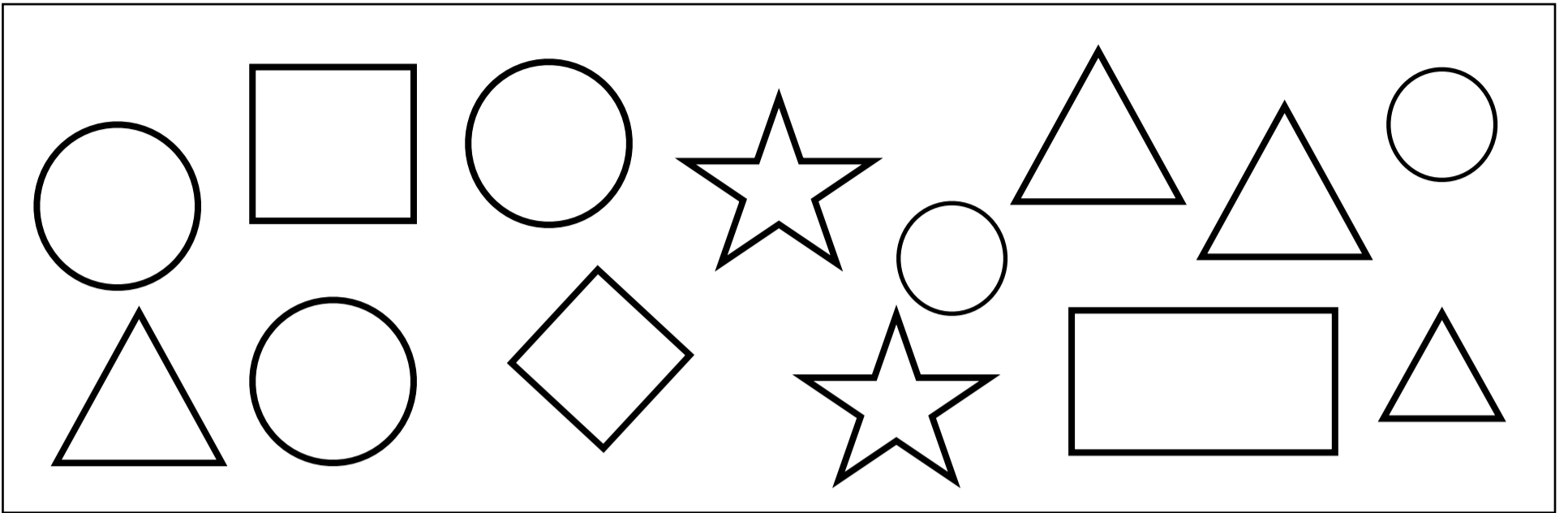



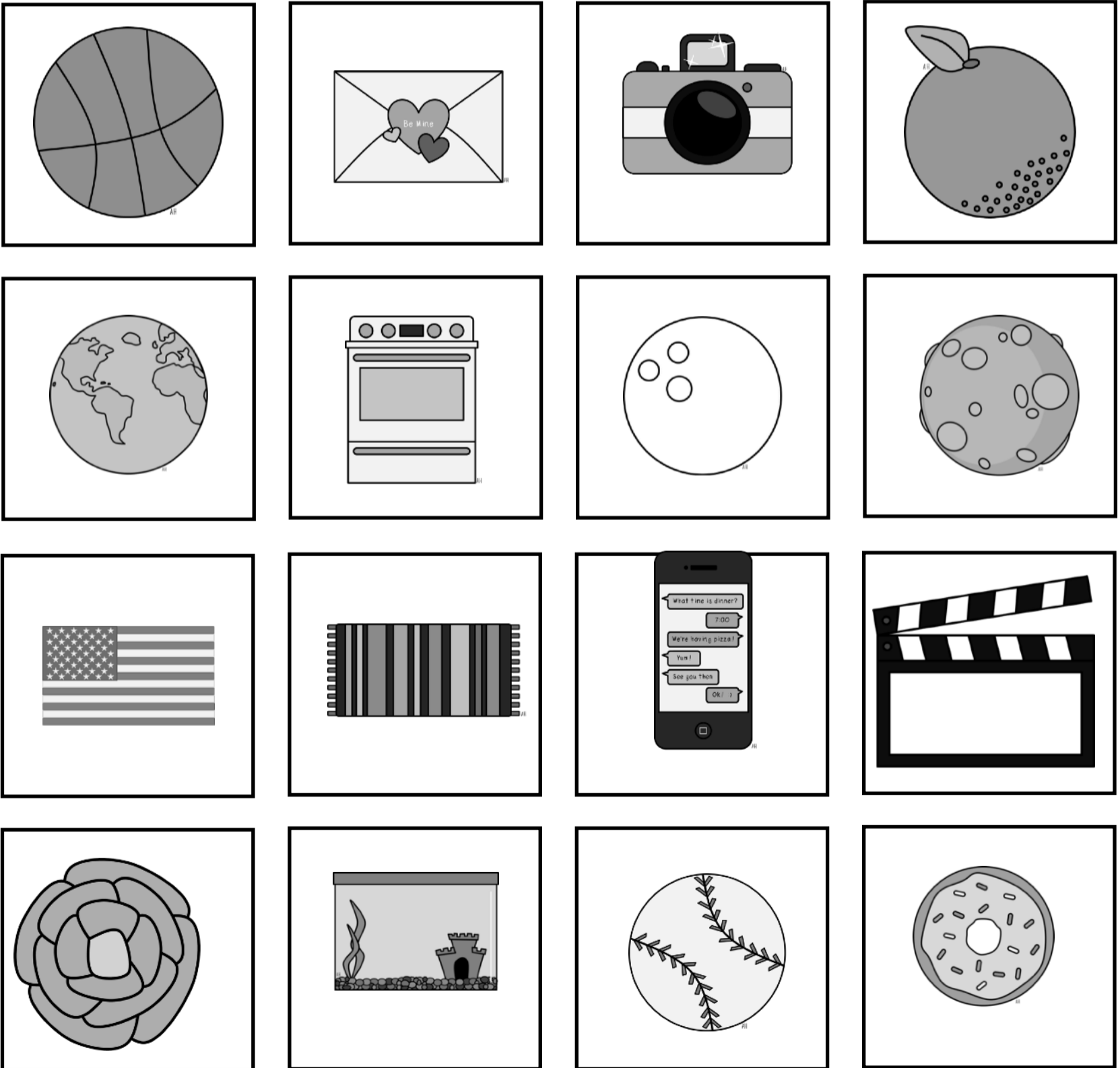

Color the ones that are a circle:



Match the numbers:



5	4	1	2
4	5	5	3
3	2	3	4
1	1	4	1
2	3	2	5

Count and Match:

1	
2	
3	
4	
5	

Color the correct shape:

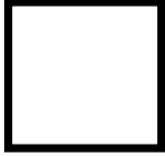
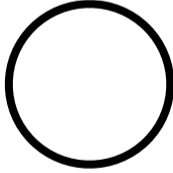
star

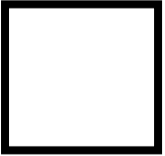
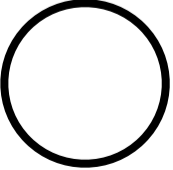
		
square		
		

Count and Match:



3

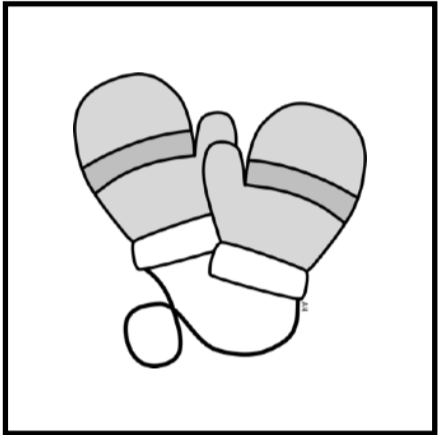

2

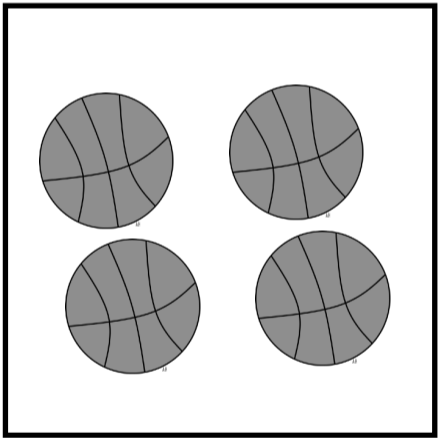

5

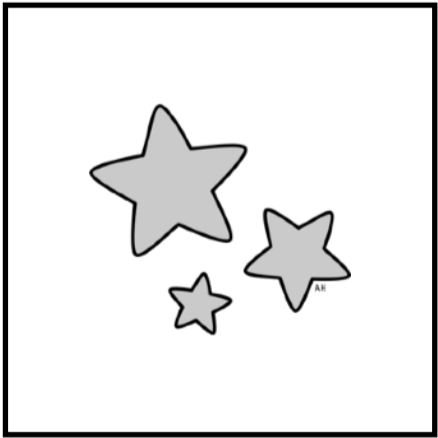

4

How many?

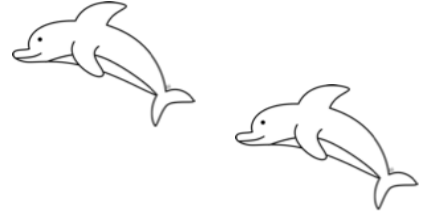

2 1 3

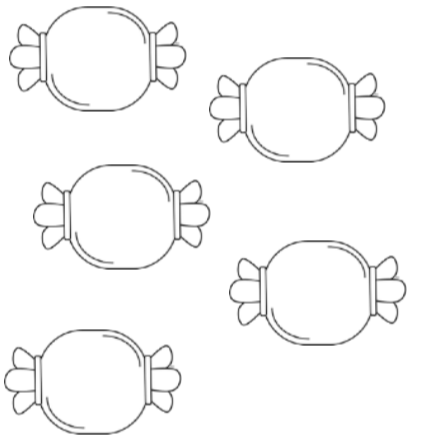

5 3 4

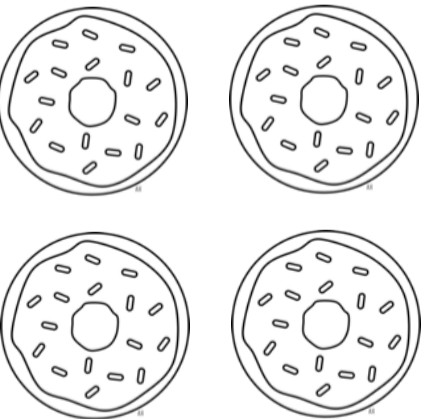

4 1 2

Trace the numbers:

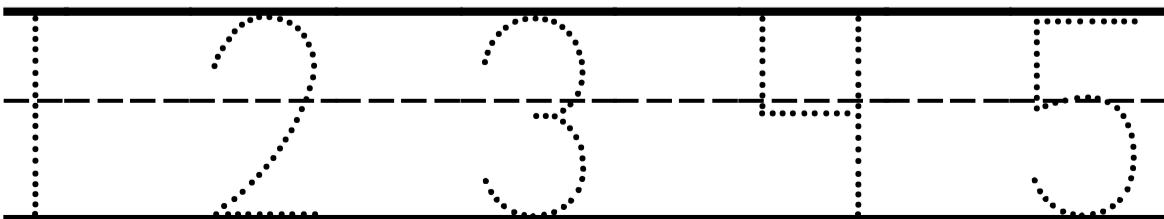

Trace the numbers:

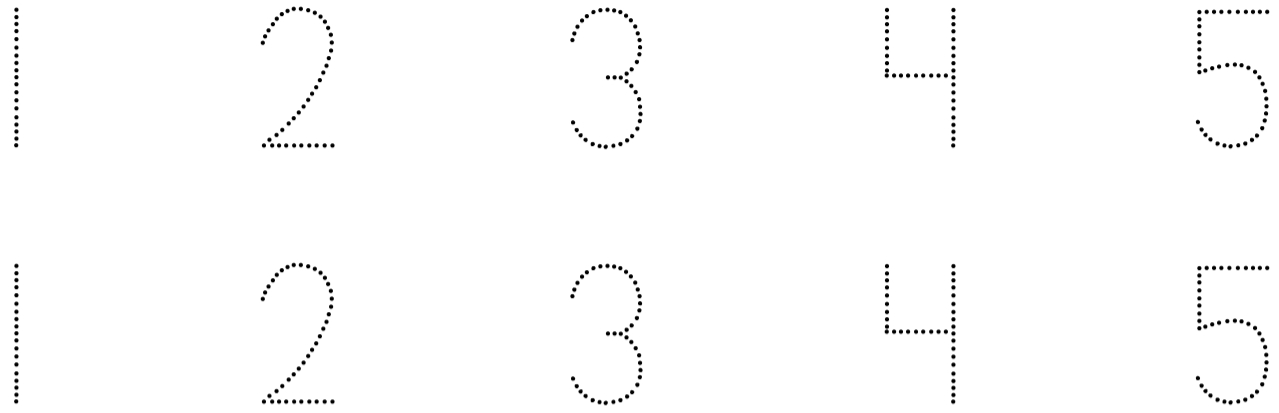

Practice writing the numbers:

5

3

1

4

2

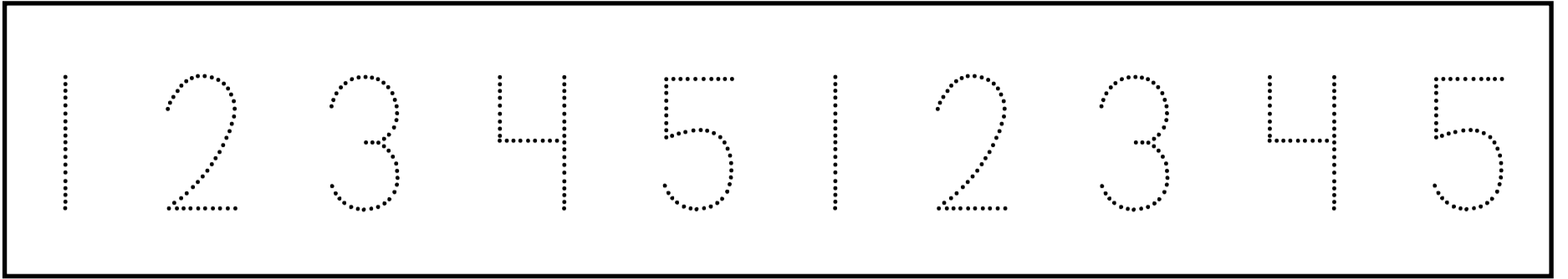

Find the numbers:

5	3	2	3	4	7	6	7	9	2	1
3	6	4	8	7	1	6	3	2	7	5
7	6	2	3	5	4	6	7	3	2	5
7	6	8	7	1	0	9	2	3	6	7
9	1	8	7	6	2	3	7	9	6	1
5	4	7	6	9	2	3	5	7	9	6
4	5	7	2	3	0	9	3	8	2	4
5	6	7	6	8	7	2	5	1	4	3

8	3	1	2	7	4	6	8	3	9	2
7	6	5	9	8	7	6	4	3	9	8
9	7	5	8	3	4	7	8	4	5	7
6	8	9	5	7	9	9	7	7	8	4
5	0	8	7	8	9	7	3	2	9	4
2	3	4	2	3	9	0	0	9	0	0
9	2	3	4	2	3	7	9	8	7	0
4	3	5	7	7	8	6	9	8	2	3
5	6	0	8	2	4	8	8	8	9	0

Circle all of: **6**

Circle all of: **9**

Match the numbers:

Write the numbers:

5	4
4	5
2	3
1	2
3	1

5	
4	
3	
2	

5 2 4 3 1 2 4 5 3 4 1

Color the triangles: 

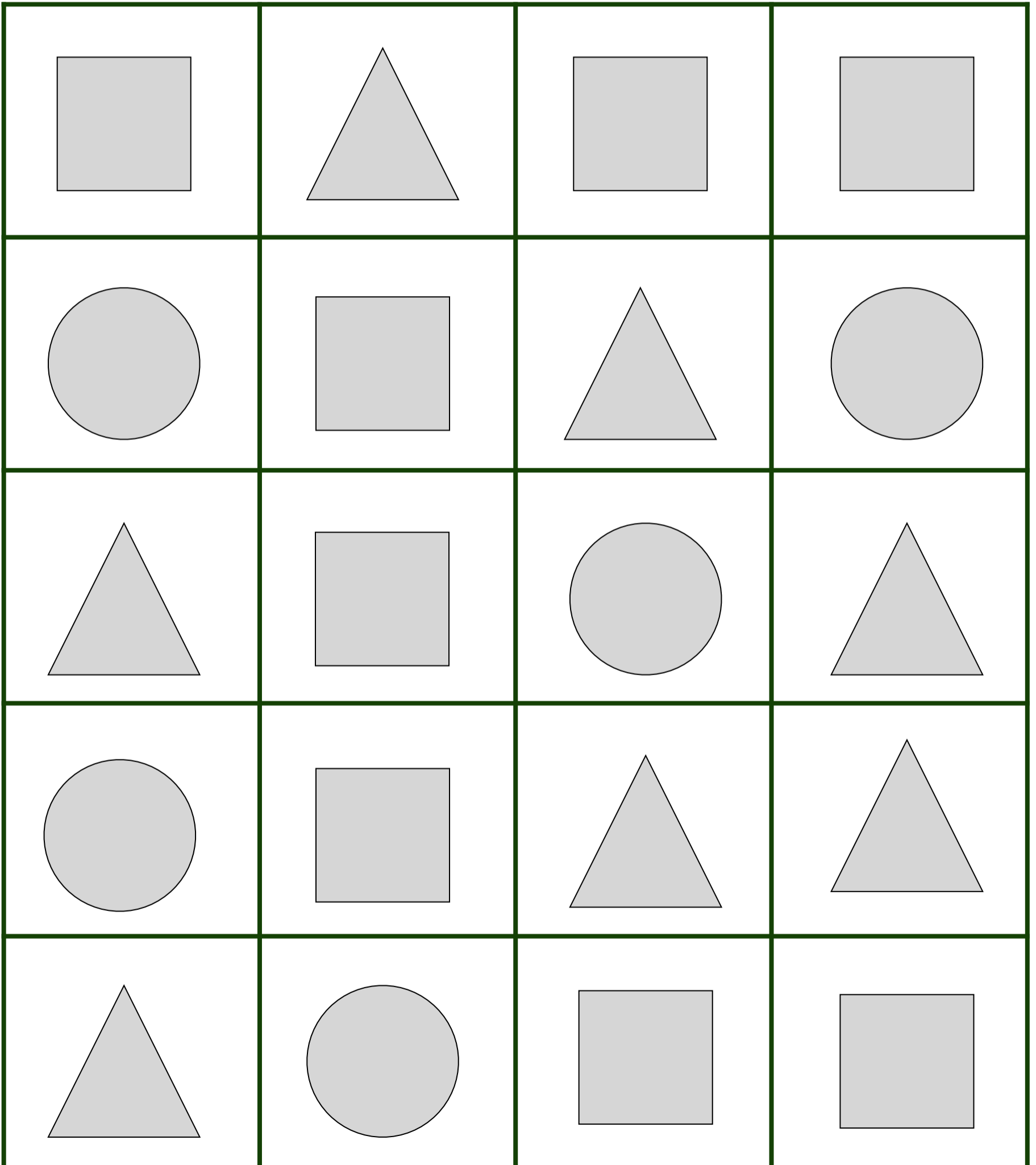

Count and Match:

1	★ ★ ★ ★ ★
2	★ ★ ★
3	★
4	★ ★
5	★ ★ ★ ★

Color the numbers:

2 4

5

Copy the number:

5	□	3	□	2	□	4	□	1	□
1	□	2	□	3	□	4	□	5	□
5	□	4	□	3	□	2	□	1	□

Answer the questions:

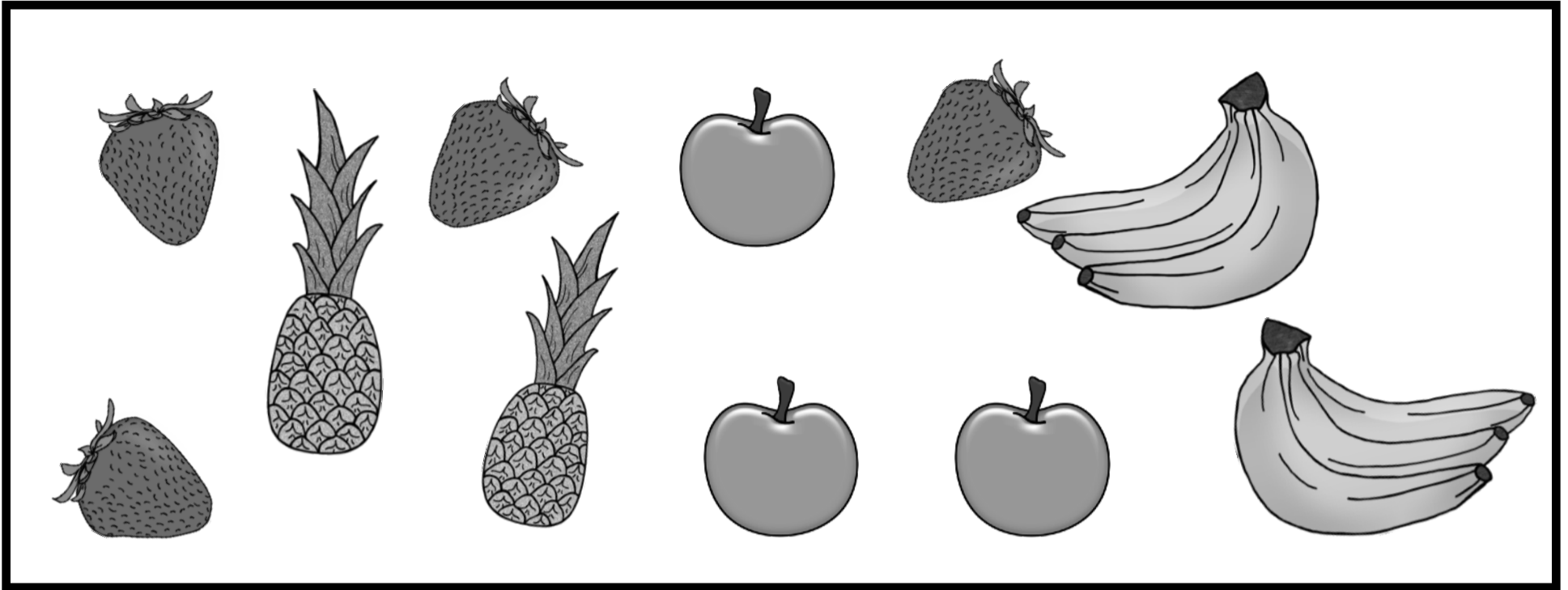

 1. How many apples are there? _____

 2. How many strawberries are there? _____

 3. How many pineapples are there? _____

Match:

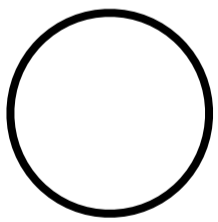

star

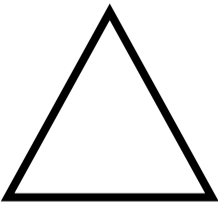



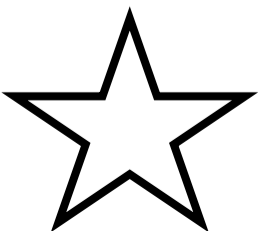

circle



triangle

Circle the correct number of items:

	<input type="text" value="3"/>	<input type="text" value="5"/>
	<input type="text" value="1"/>	<input type="text" value="3"/>
	<input type="text" value="2"/>	<input type="text" value="3"/>
	<input type="text" value="3"/>	<input type="text" value="4"/>
	<input type="text" value="4"/>	<input type="text" value="2"/>

Find all of the:

5

2

3

5

2

4

4

1

2

1

3

6

2

3

5

4

1

5

2

1

4

2

Count and Match:

1



2



3



4



5



Circle the correct number of items:



2

4



1

3



5

3

Trace the numbers:

1

2

3

4

5

Find all of the **stars**:

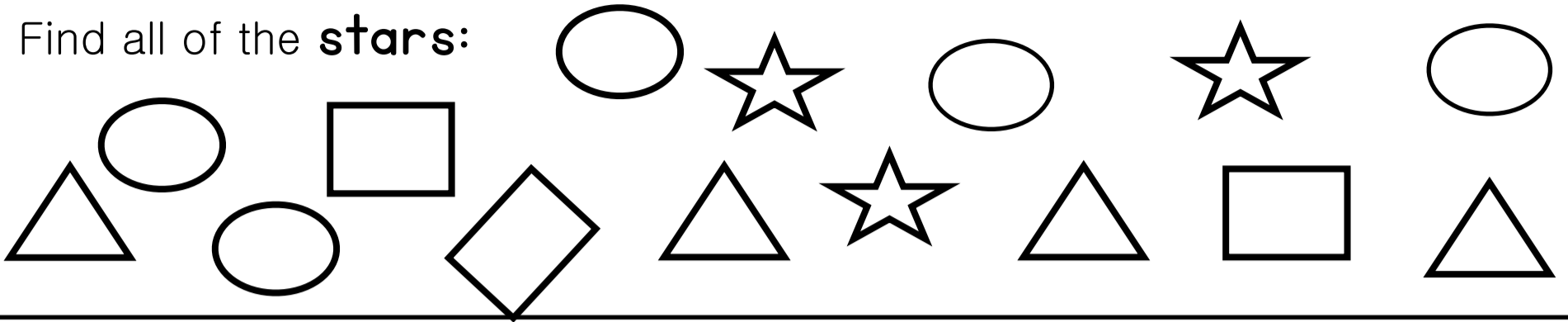



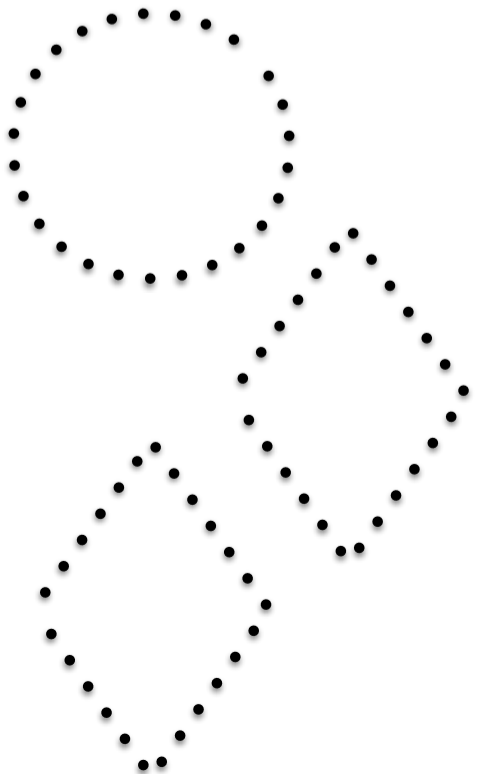
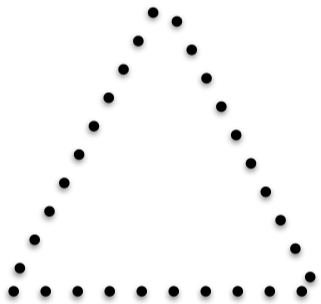
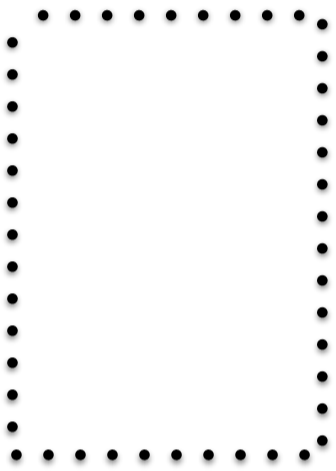

Trace the shapes:

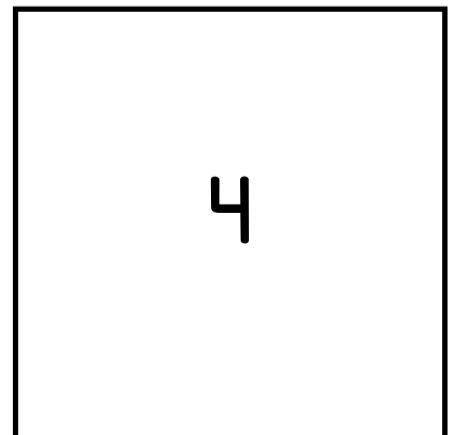
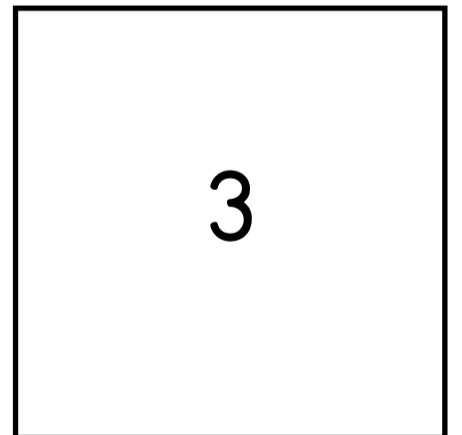
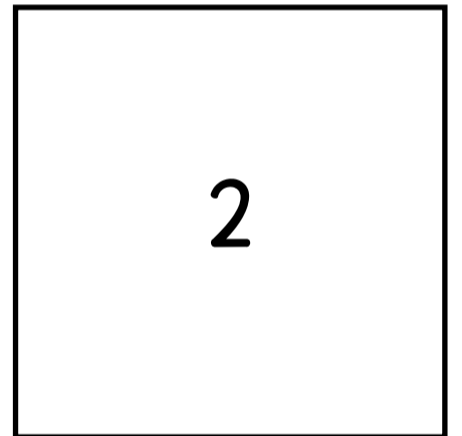
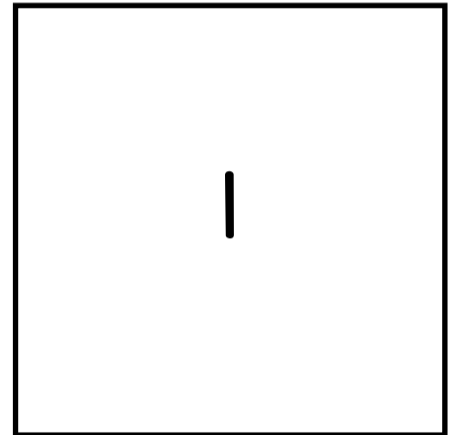
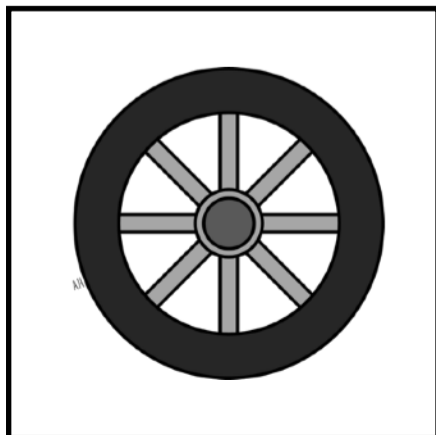
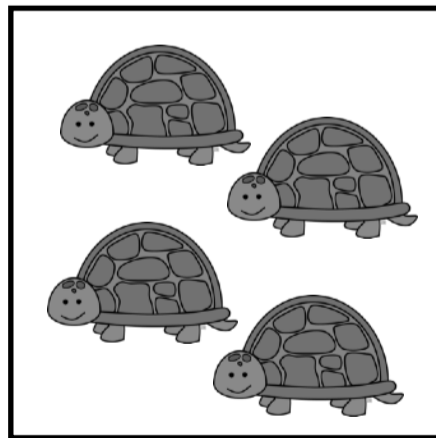
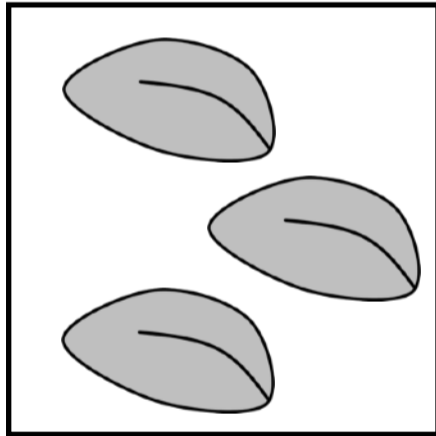
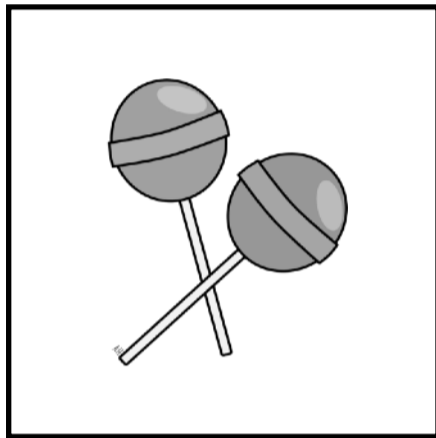

Count and Match:



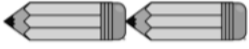

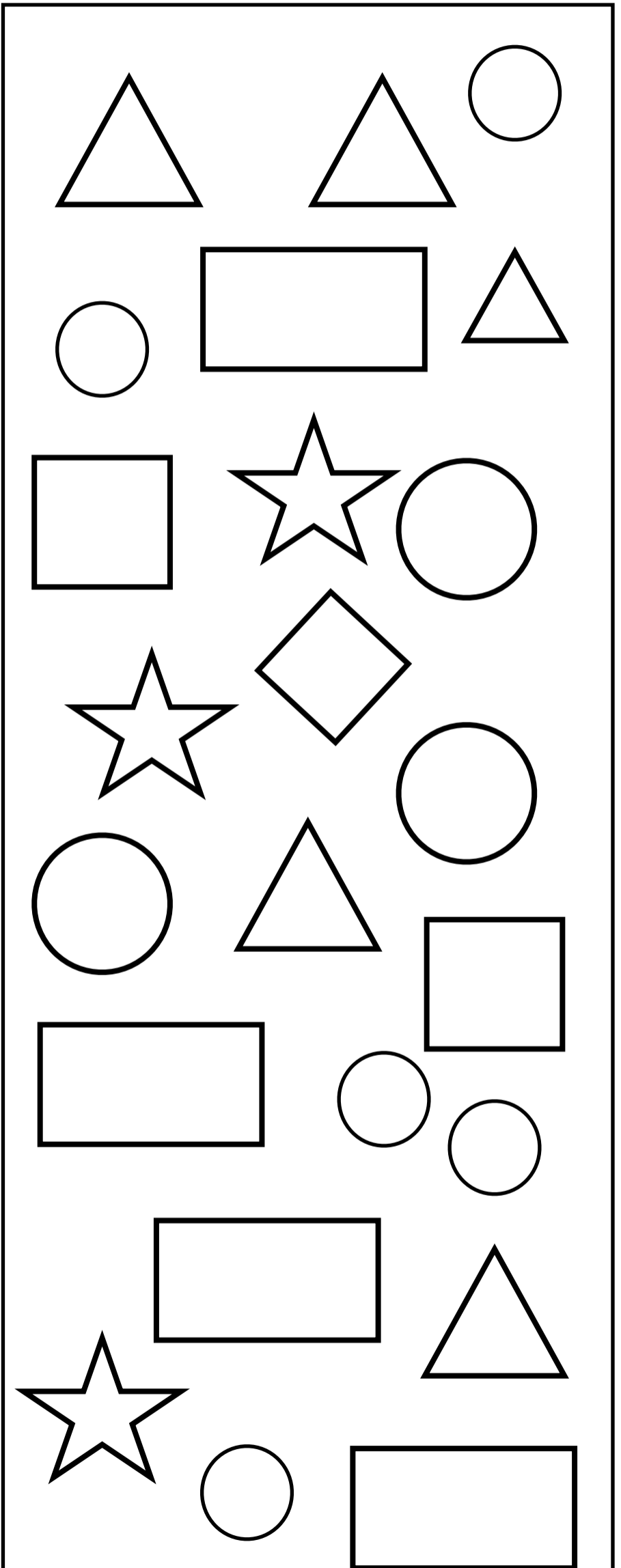

Count and Match:

1	
2	
3	
4	
5	

Color all of the **rectangles**:



Circle the correct number of items:

	2	3
	3	4
	2	1
	3	4

Trace the numbers:

1 2 3 4 5

How many?



2 4 5

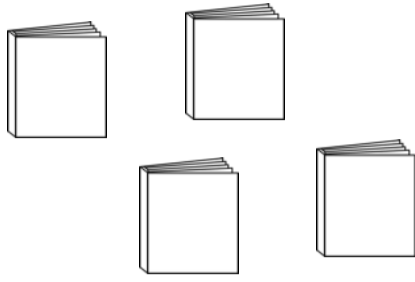

5 3 4



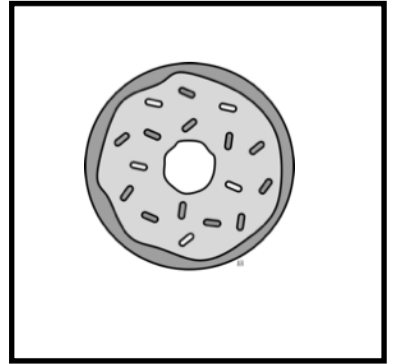
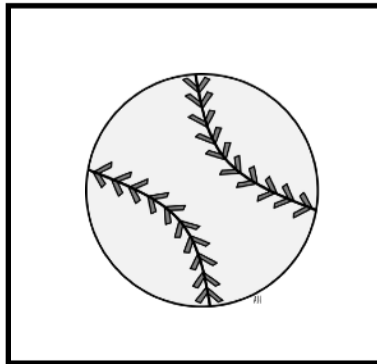
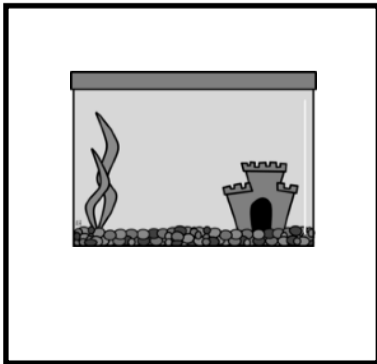
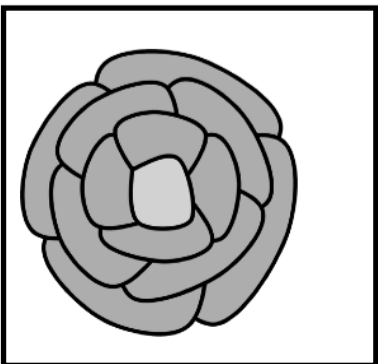
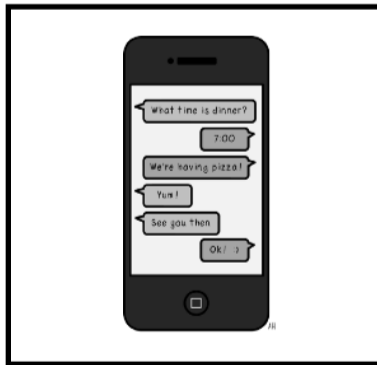
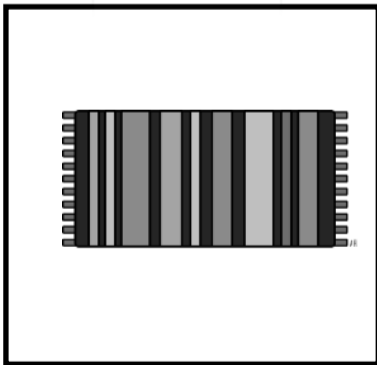
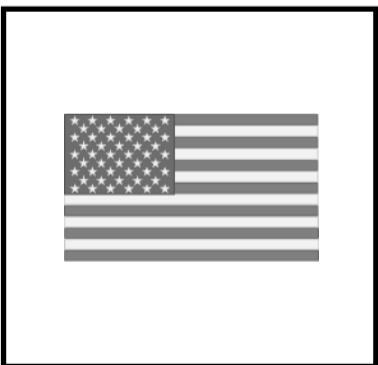
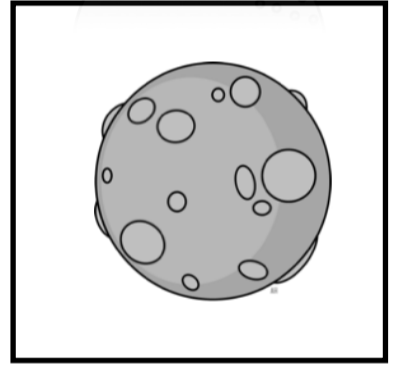
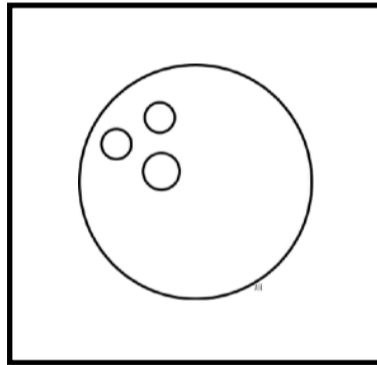
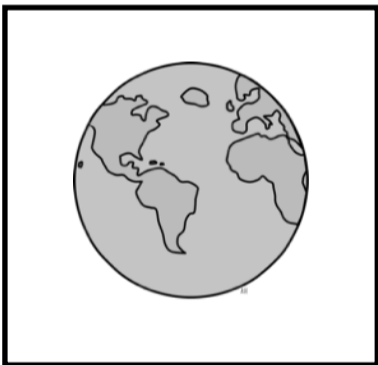
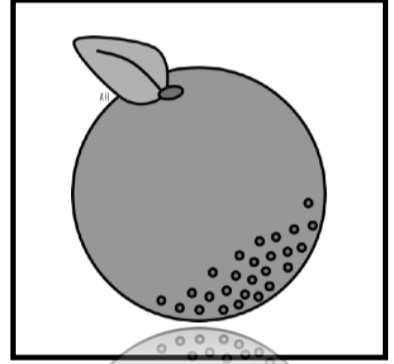
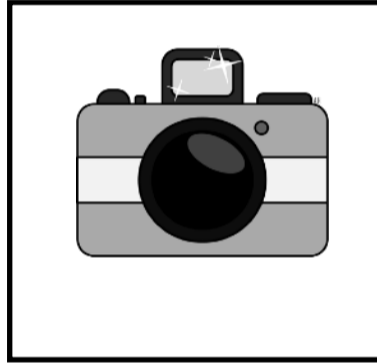
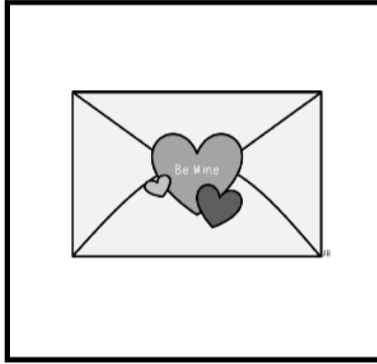
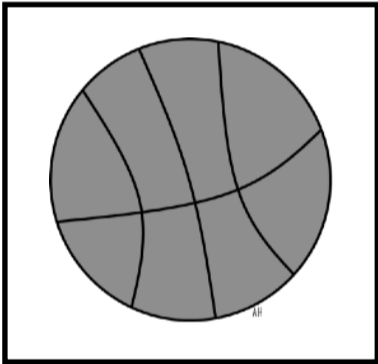

5 1 4

Color the rectangles:

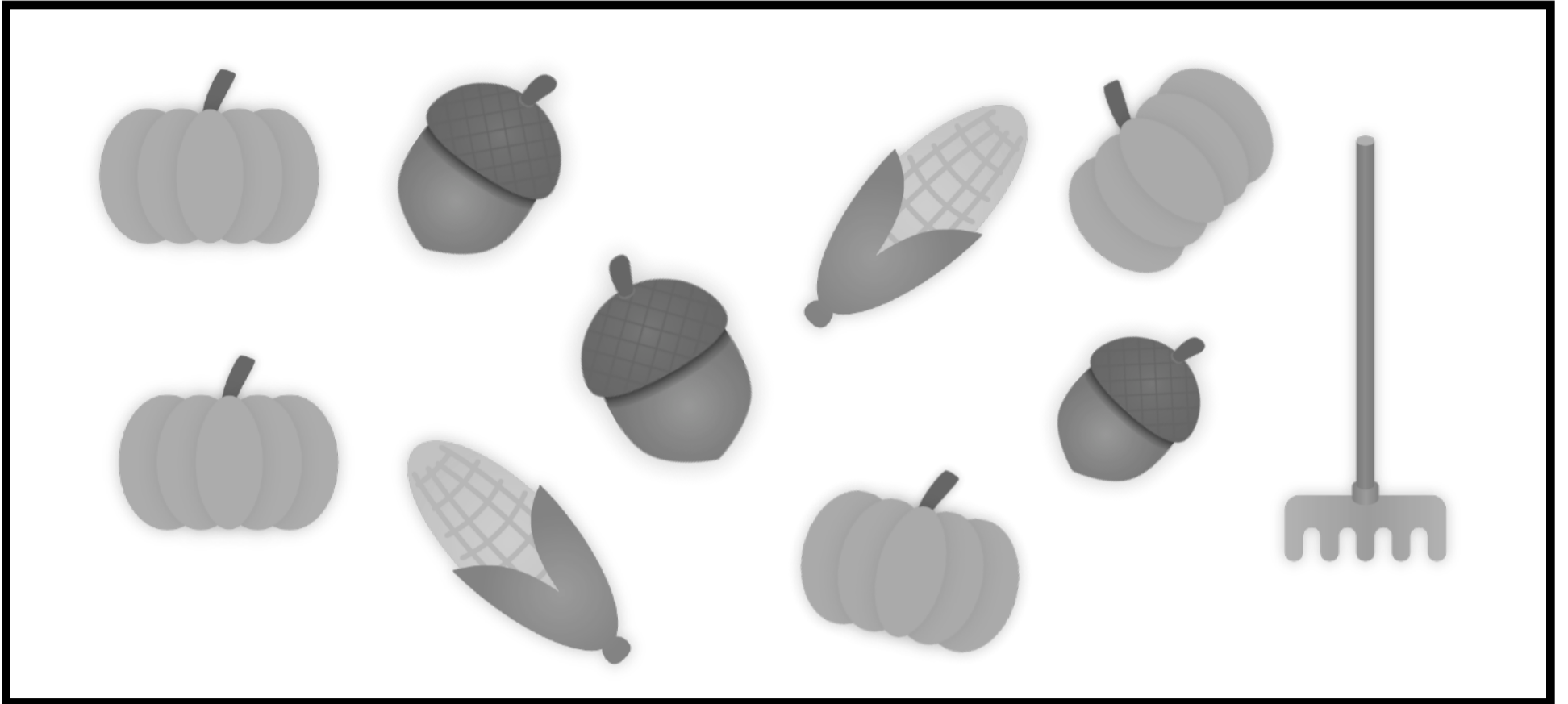

Answer the questions:







 1. How many acorns are there? _____

 2. How many ears of corn are there? _____

 3. How many rakes are there? _____

Count and Match:

1	
2	
3	
4	
5	

Match the name to shape:



diamond

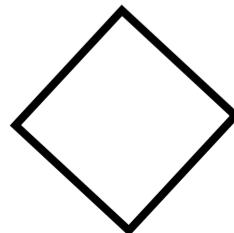

rectangle



square

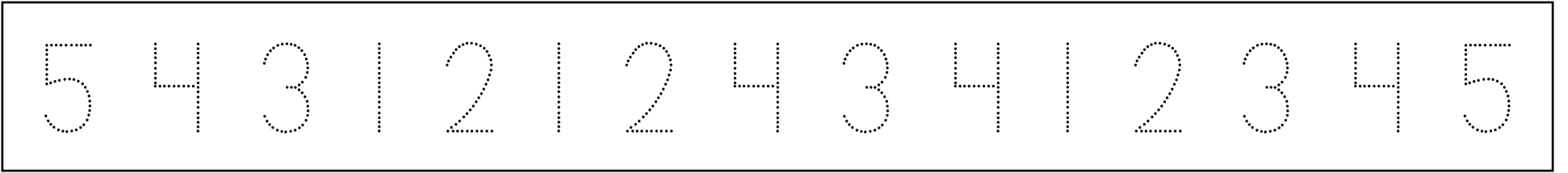









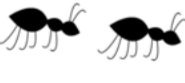

Write the numbers:

5		4		4		3	
4		4		1		5	
3		3		2		3	
2		5		5		4	
1		2		5		1	

Circle the correct number of items:

Count and Match:

	5	4
	2	3
	2	5
	3	5
	2	1

1	
2	
3	
4	
5	

5 4 3 1 2 1 2 4 3 4 1

How many?

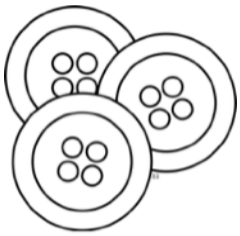

3 5 4



1 2 3



2 3 4

Count and match:

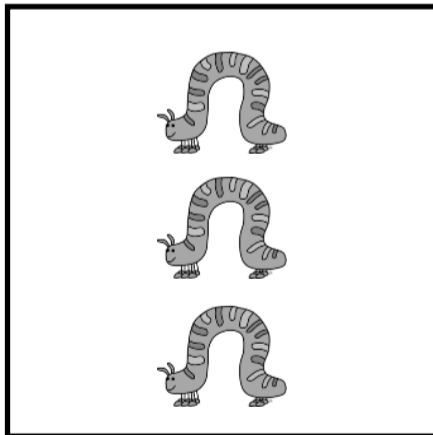
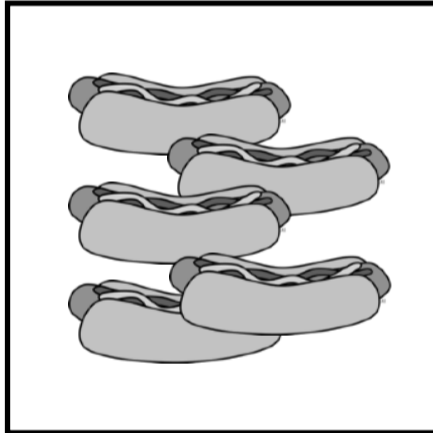
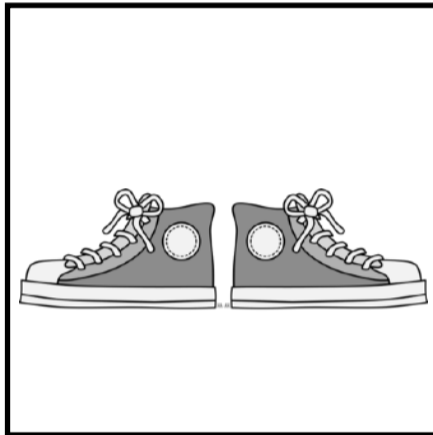

1

2

3

5

How many?

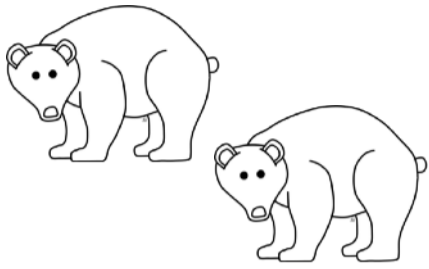

1	2	3
---	---	---

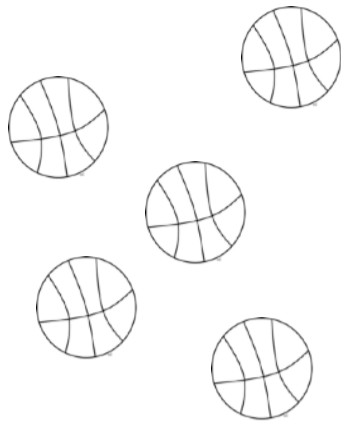

3	4	5
---	---	---

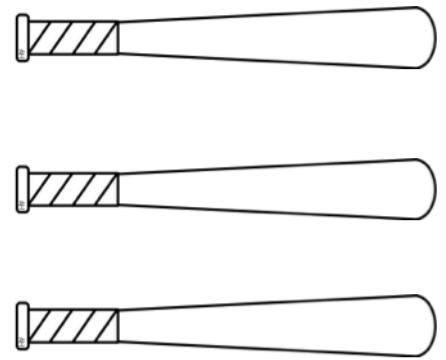

2	3	4
---	---	---

Write the numbers:

5		4		2		4		2	
3		4		5		3		1	

Count and Match:

1	
2	
3	
4	
5	

Circle the correct number of items:

	2	3
	3	4
	2	1
	3	2
	2	5

How many?

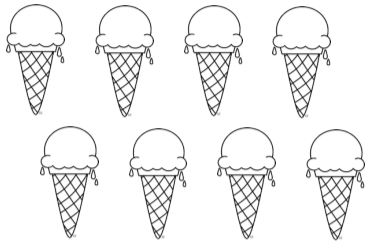

6 7 8

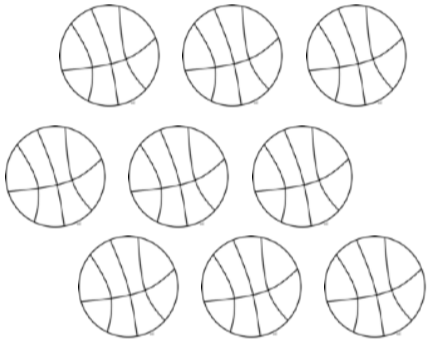

9 8 10

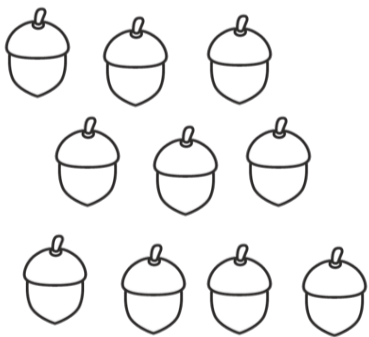

9 10 7

Count and Match:

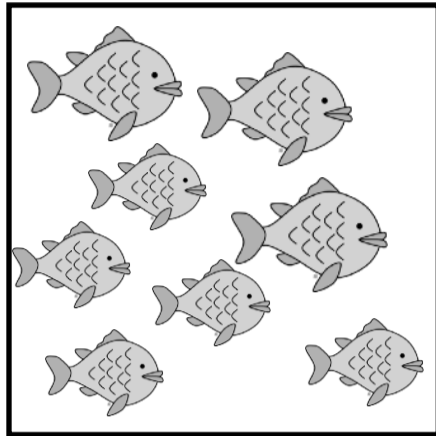

9

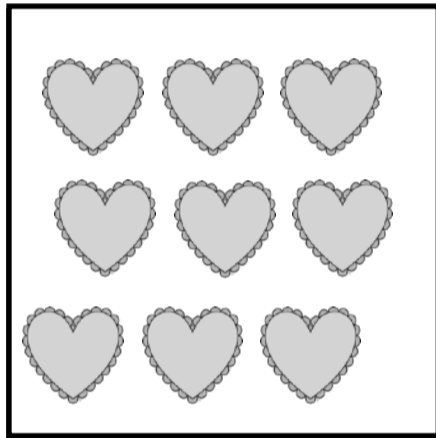

8

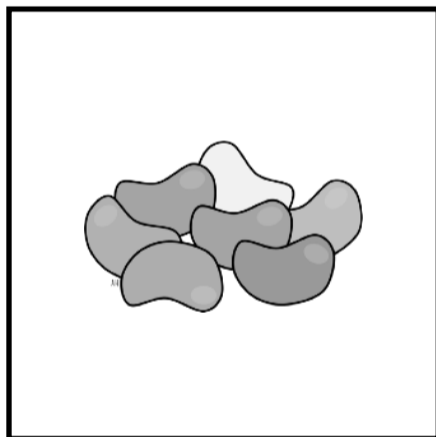

6

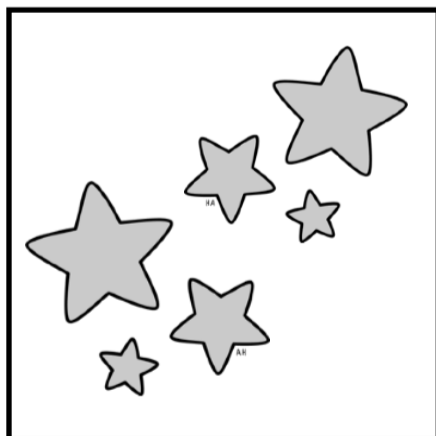

7

Trace the numbers;

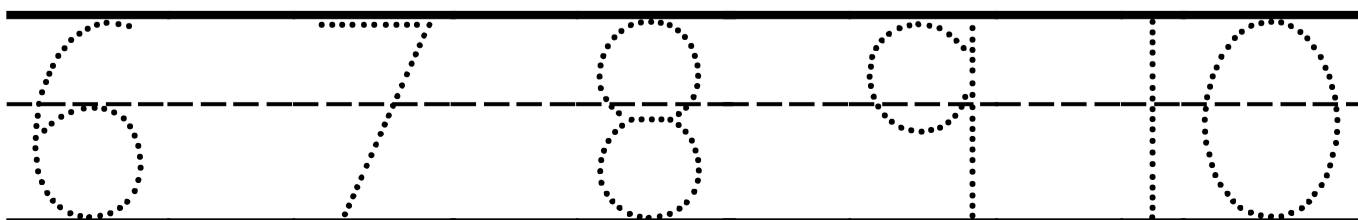

Count and Match:

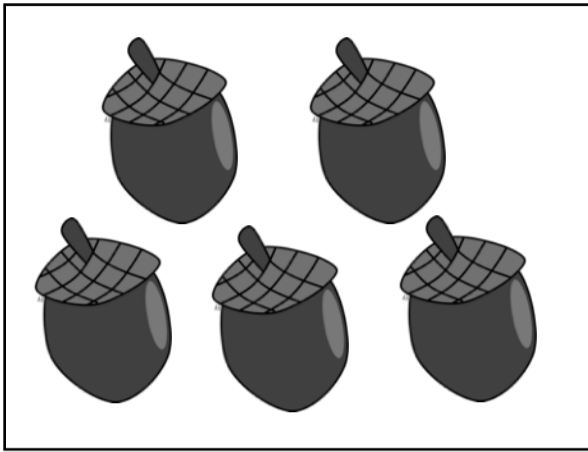

8

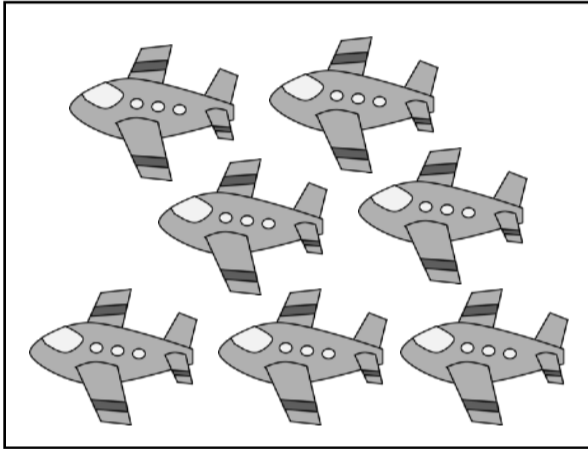

5

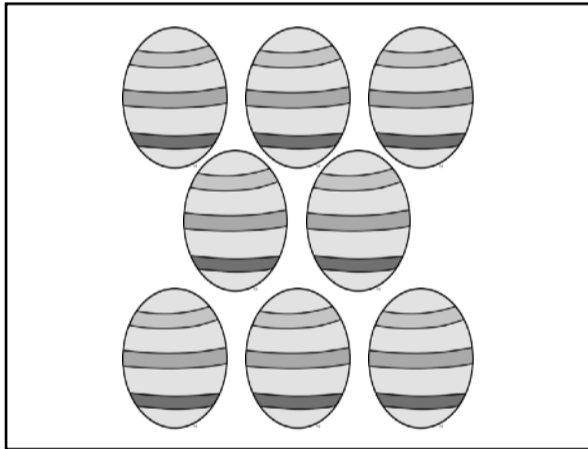

9

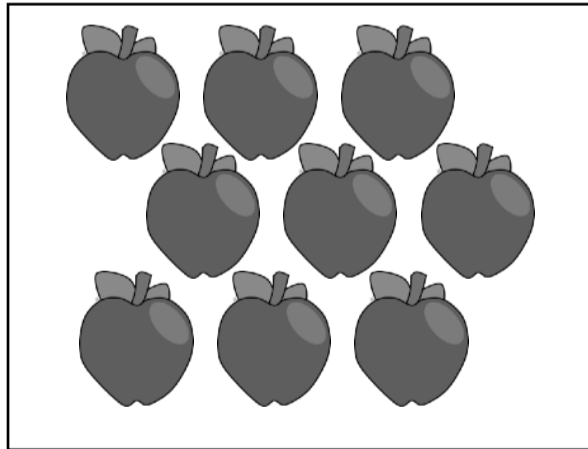

7

Trace the shapes:

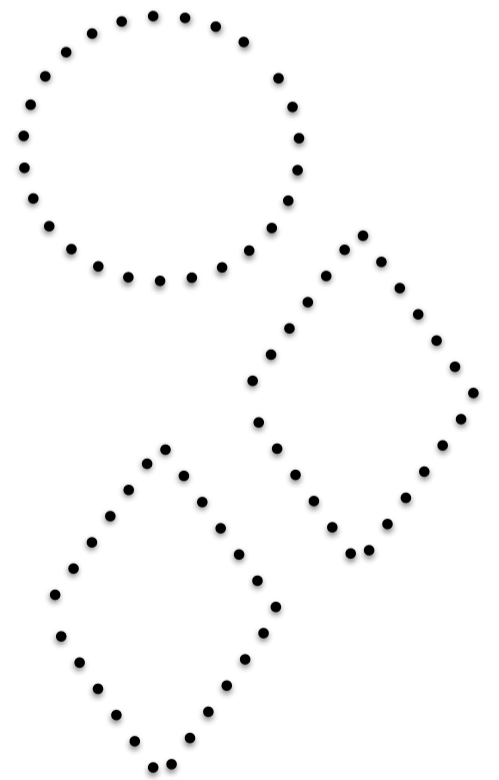
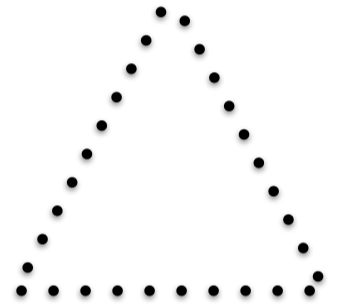
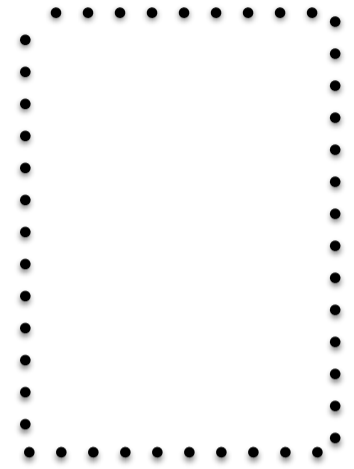

Trace the numbers;

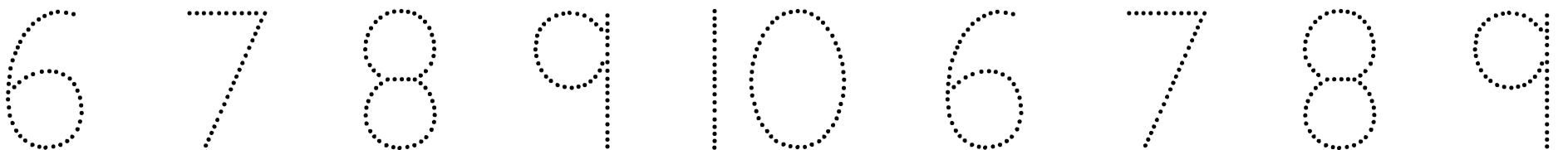

Find the numbers:

8 7 9 4 8 3 5 7 9 3 6
8 7 9 6 3 4 9 8 5 7 6
3 8 4 6 5 8 9 7 6 9 8
7 6 8 8 8 7 0 9 9 9 6
8 4 9 9 8 4 5 3 4 9 8
9 9 8 5 4 7 6 9 8 7 9
8 7 4 5 6 9 8 7 4 5 9
8 6 7 4 9 5 8 7 6 3 9
8 7 4 9 5 8 6 7 9 4 9

Circle all of: **9**

Find the numbers:

8 7 4 9 8 7 8 1 3 8 2
2 8 8 8 3 7 4 2 8 4 8
8 8 2 9 3 7 4 9 2 3 8
7 4 2 3 8 8 8 7 9 8 2
3 7 4 9 2 8 3 7 4 9 8
7 2 3 9 8 4 7 2 3 8 8
8 7 8 8 8 7 8 8 8 7 8
0 9 7 9 8 0 8 0 9 8 7
2 3 4 0 3 2 8 7 4 8 9

Circle all of: **8**

Write the numbers:

5

6

7

8

Trace the numbers:

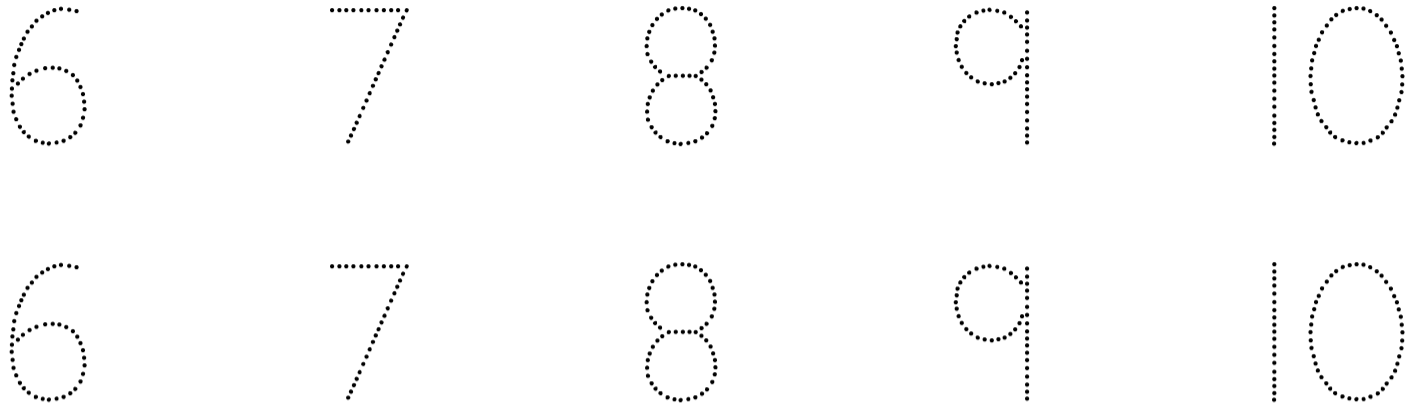

Practice writing the numbers:

7

9

10

8

6

Find all of the:

7

7

9

5

9

7

9

8

6

7

6

8

7

8

7

9

6

9

7

6

8

7

Circle the one that is bigger:

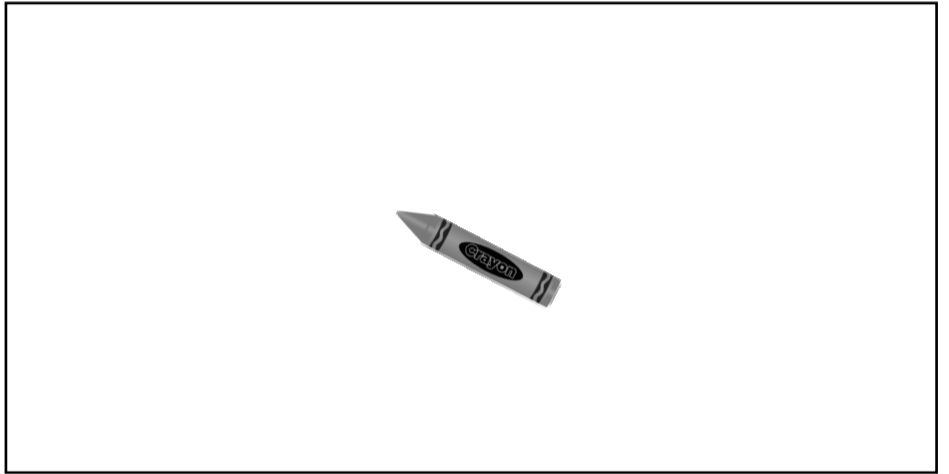

Count and Match:

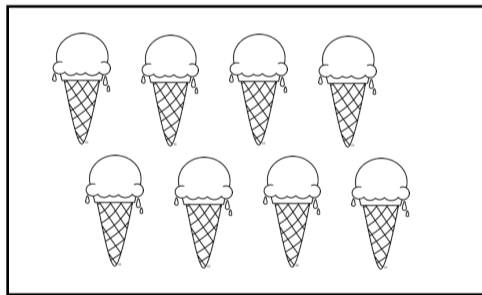

7

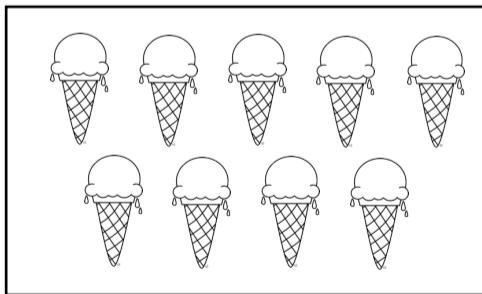

9

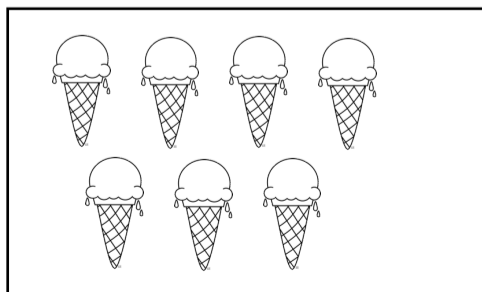

8

Write the numbers:

9		10		7		8	
9		6		7		9	

Circle the one that is bigger:



Circle the items that are big:

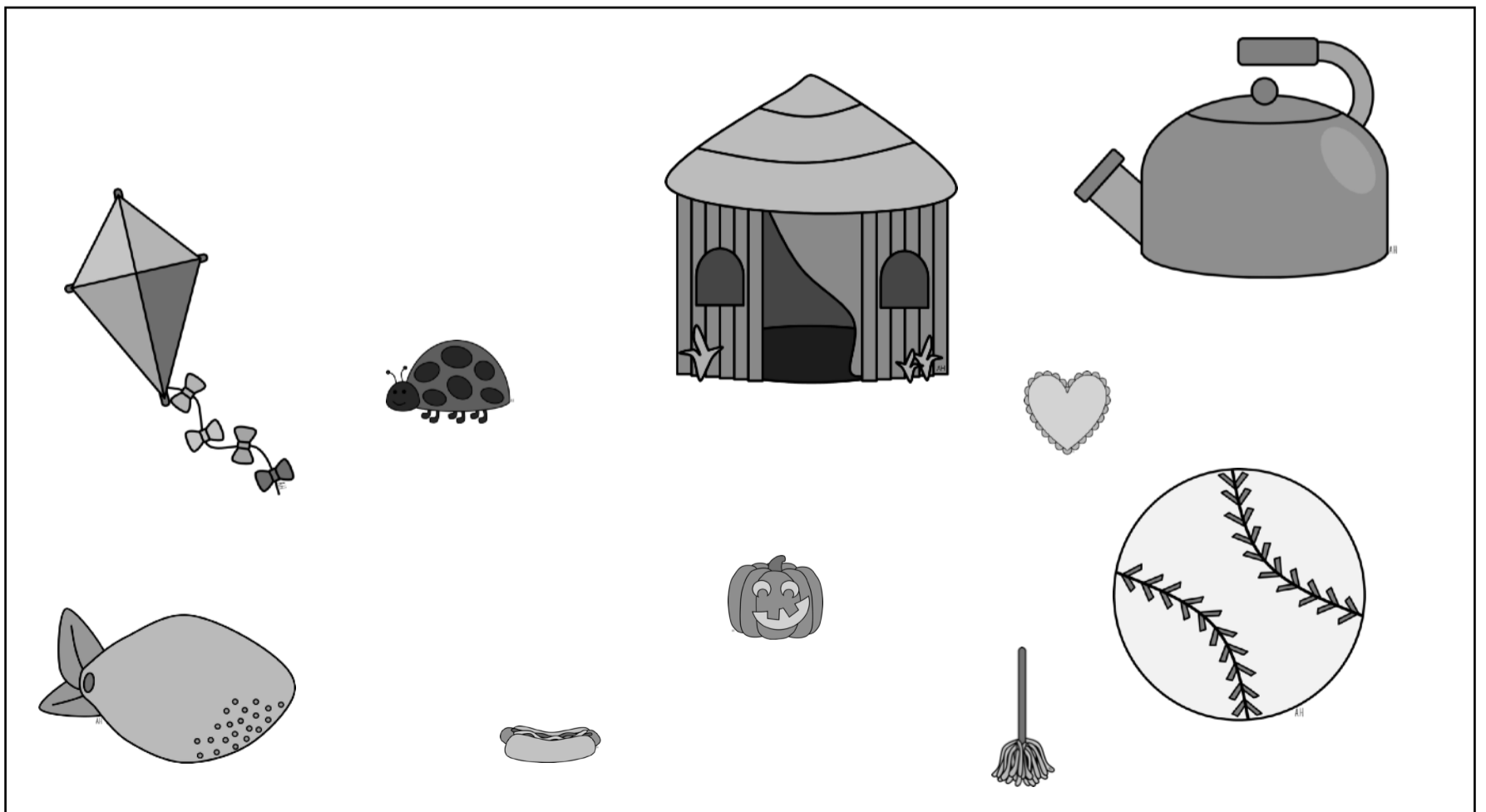
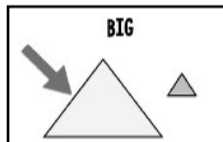

Answer the questions:

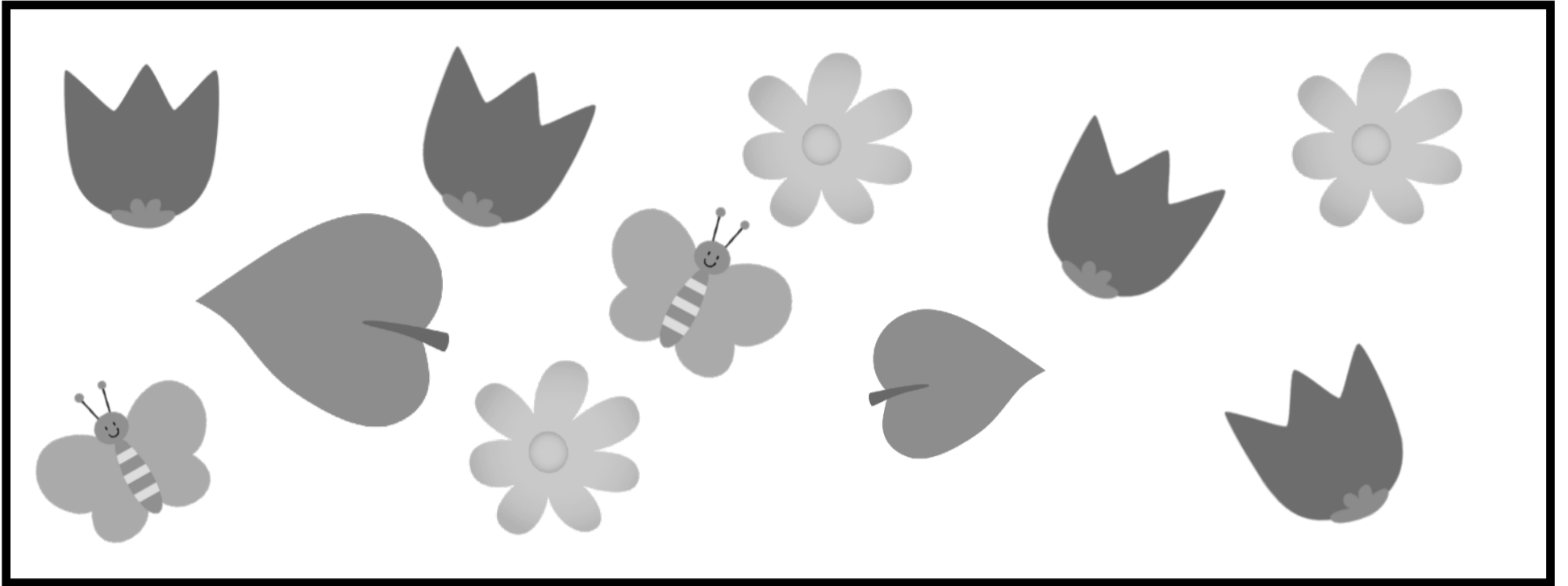

1. How many tulips are there? _____



2. How many leaves are there? _____



3. How many butterflies are there? _____

How many?

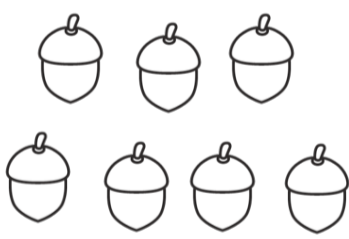

9 10 7

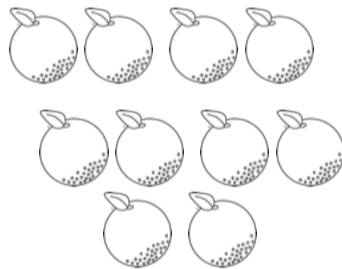

8 9 10



7 6 8

Circle the one that is bigger:

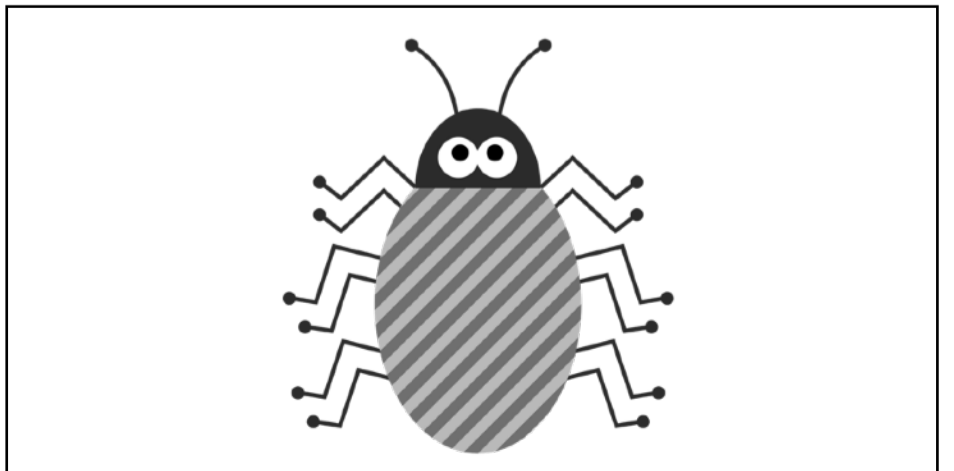
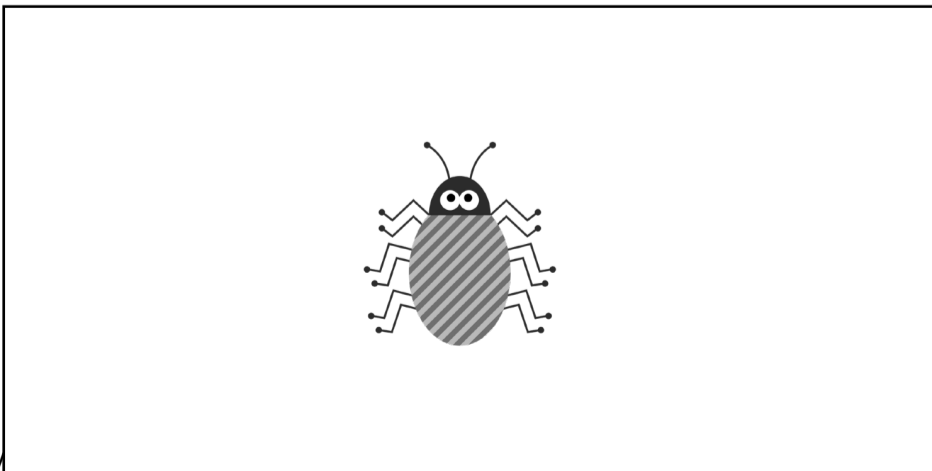

Circle the one that is bigger:

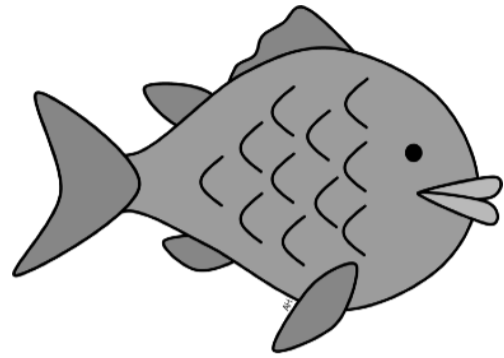
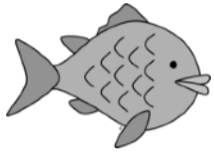

Match:

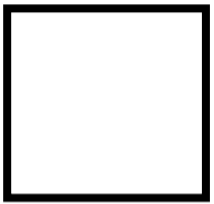

diamond

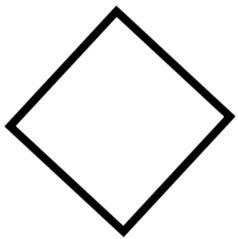

square

Trace the shapes:

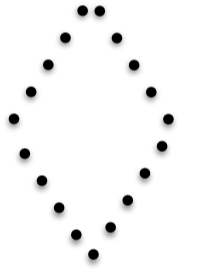
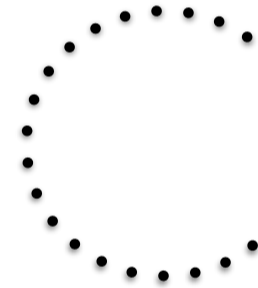
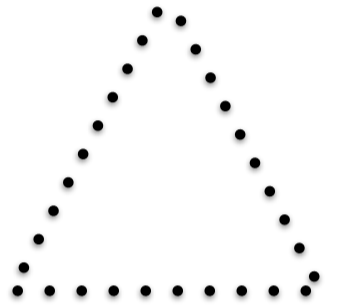
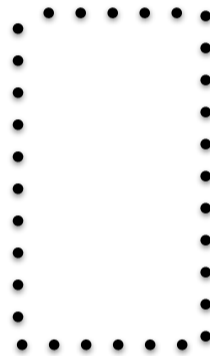

Count and Match:

1



2



3



4



5



Count and Match:

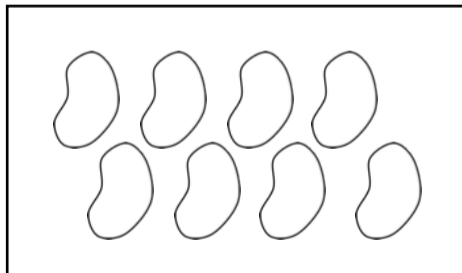

6

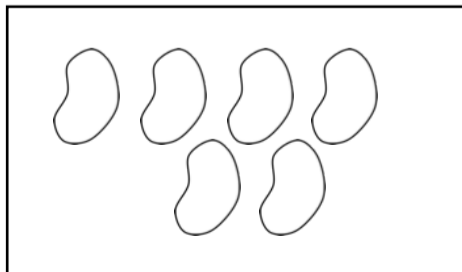

8

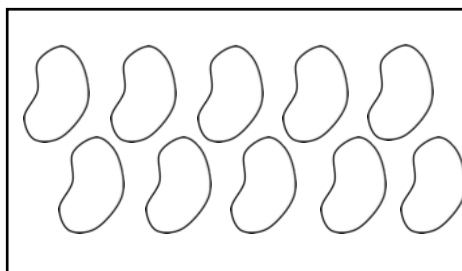

10

Circle the one that is bigger:

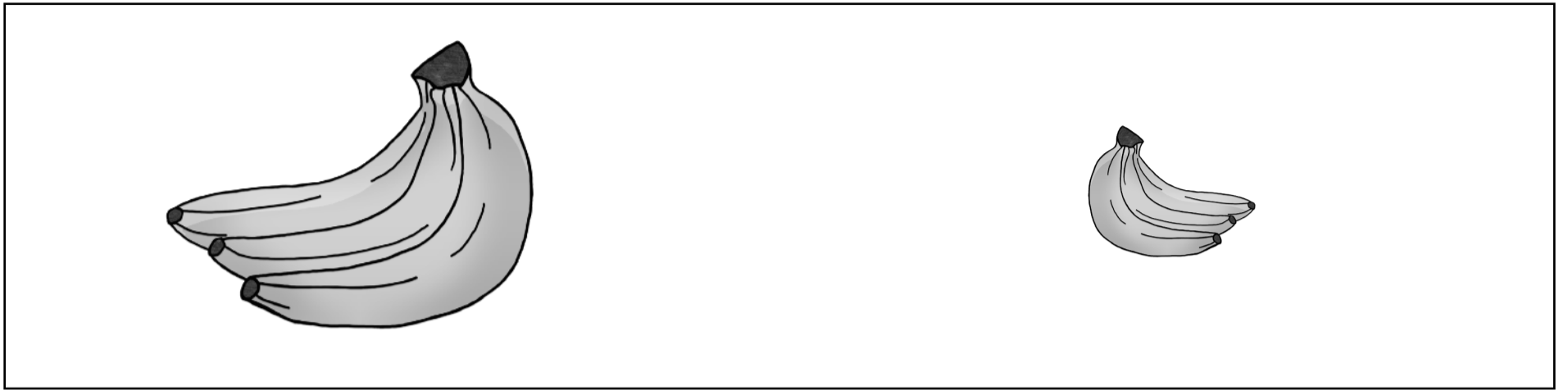

Color the correct shape:

circle

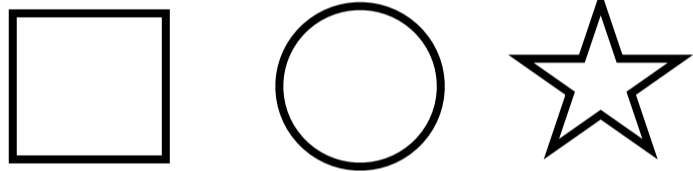

Color the correct shape:

star

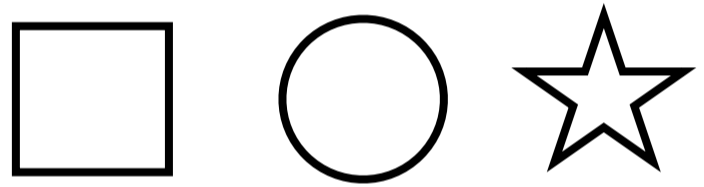

Circle the items that are big:

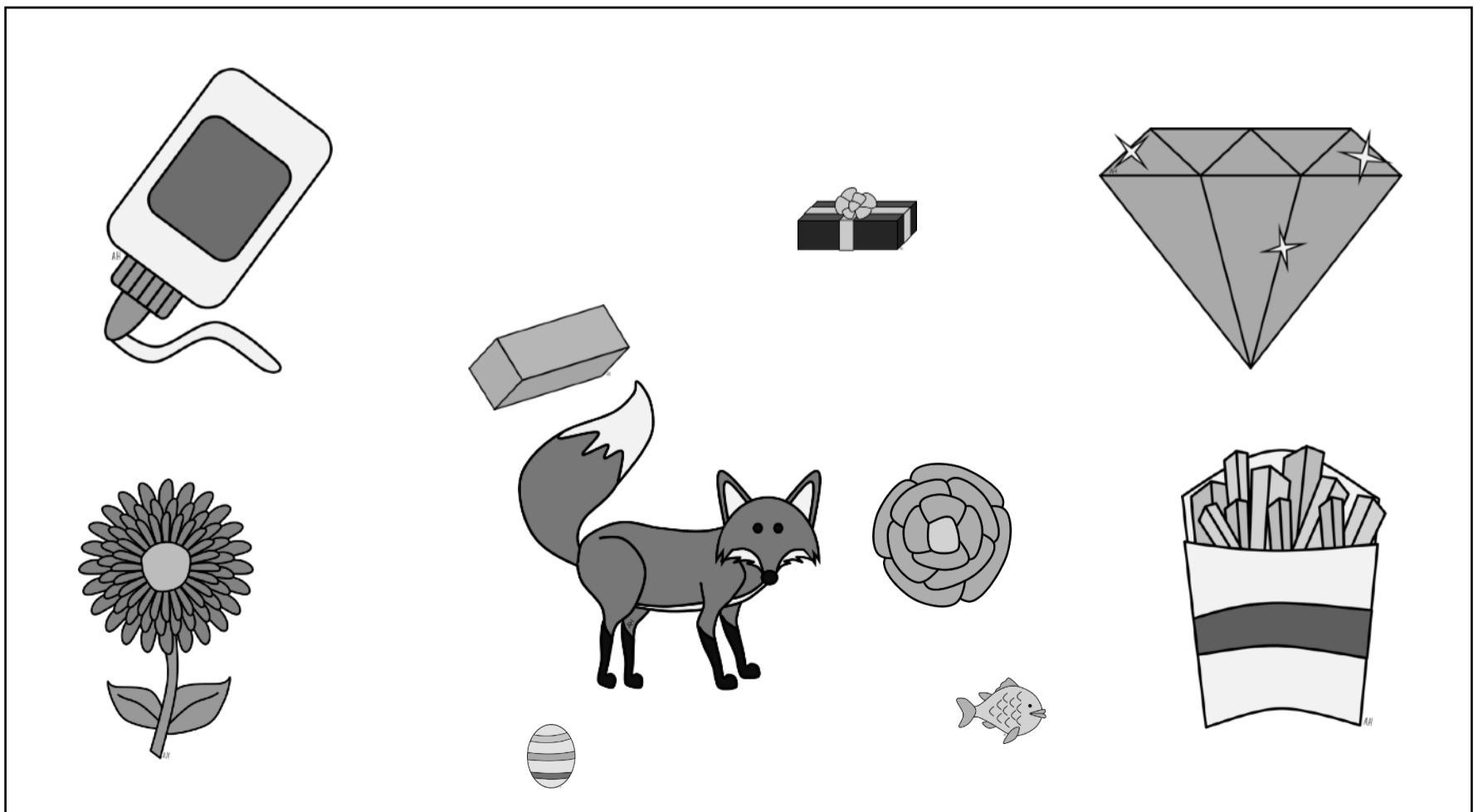
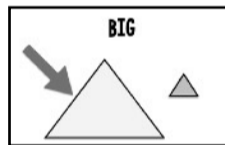

Circle the ones that are big:

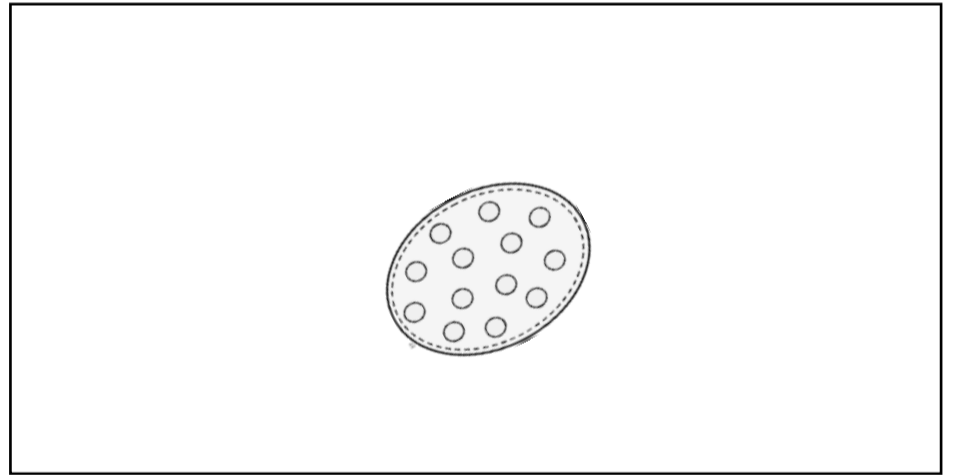
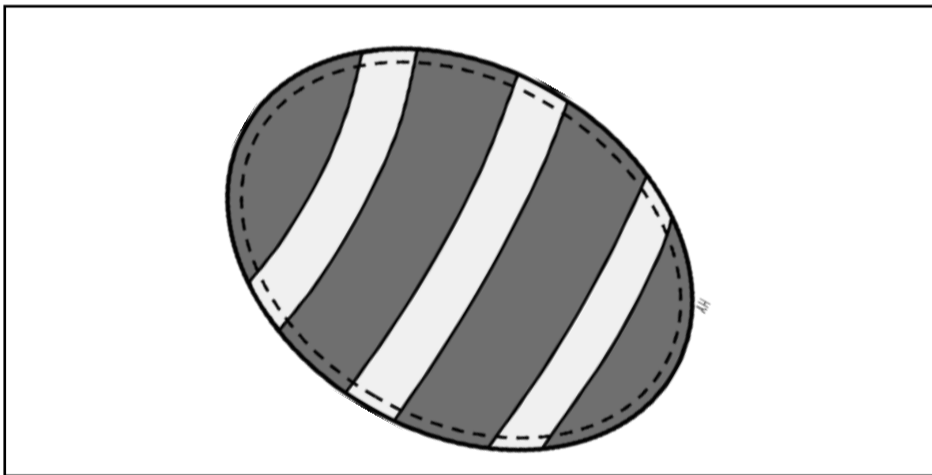
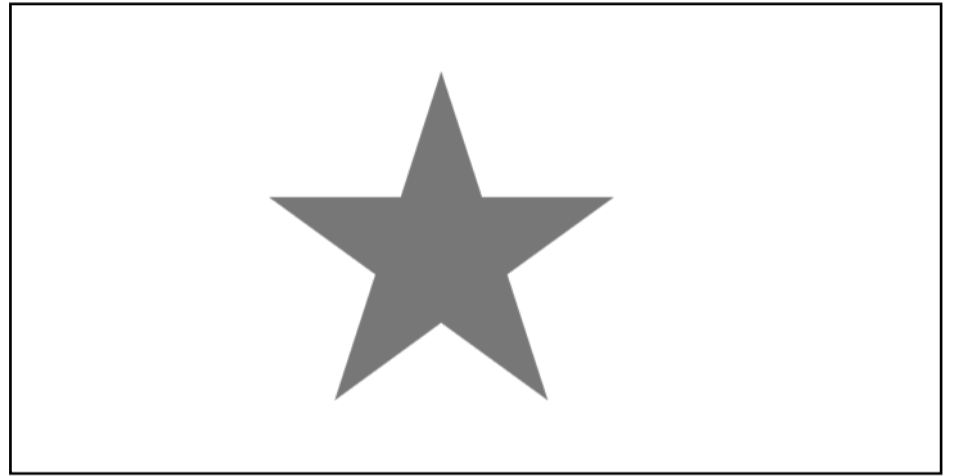
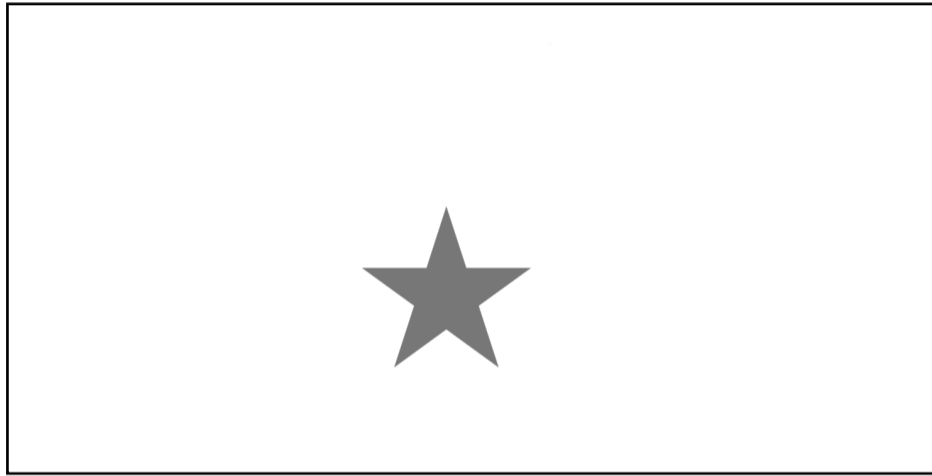
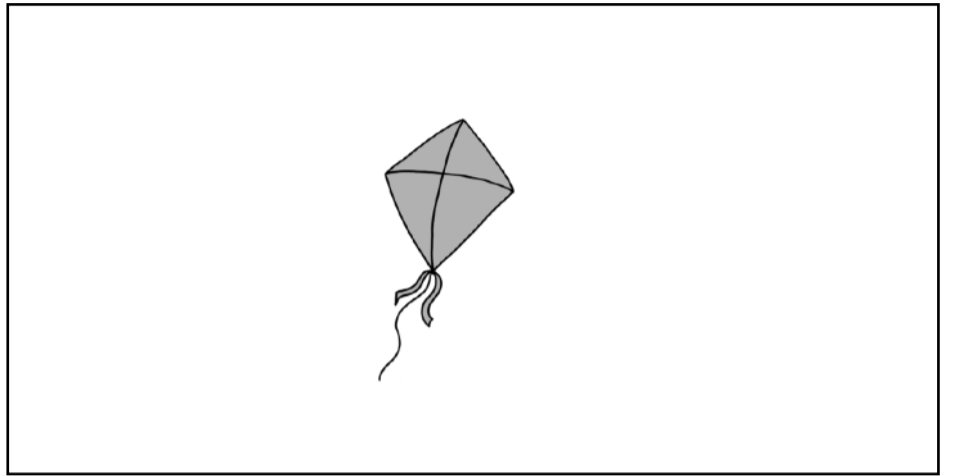
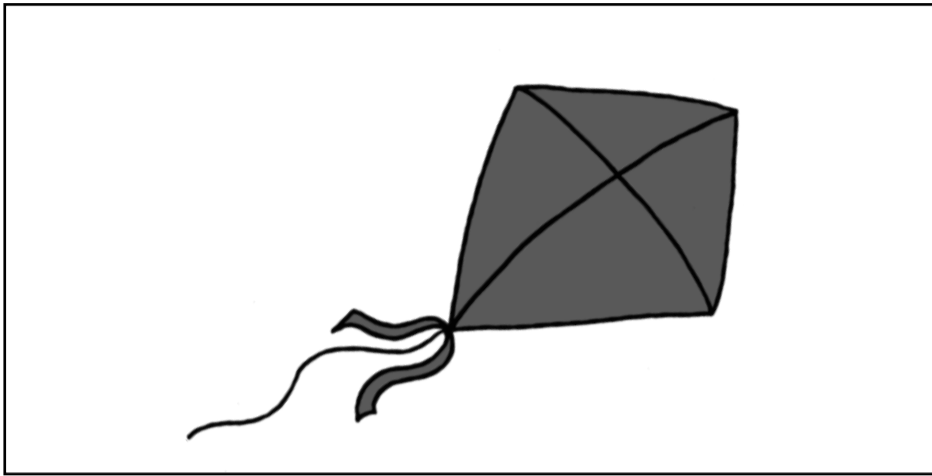

Trace the numbers:

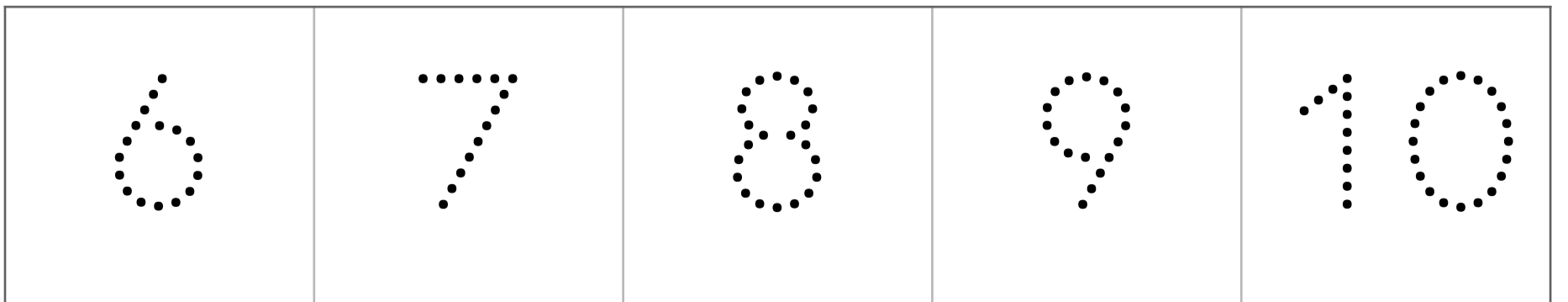
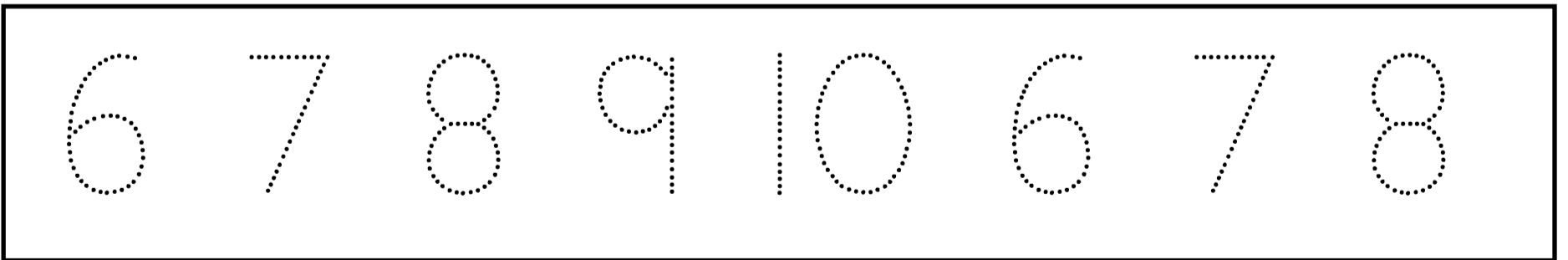

How many?

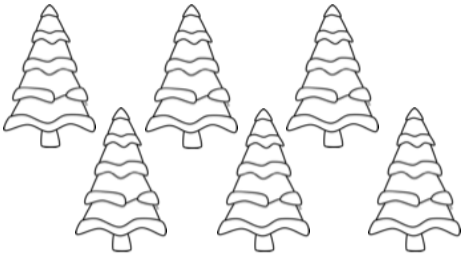

7 6 8

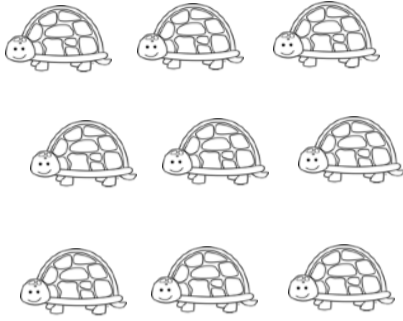

8 9 10

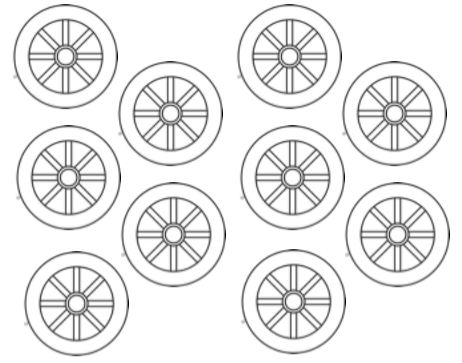

10 7 8

Count and Match:

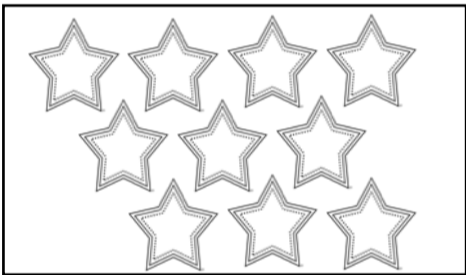

6



7

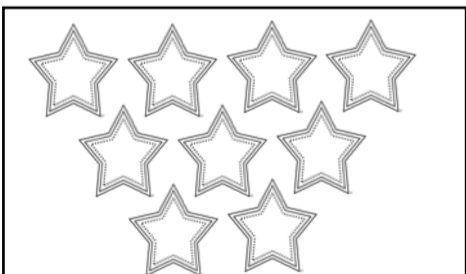

8



9



10

Find all of the **triangles**:

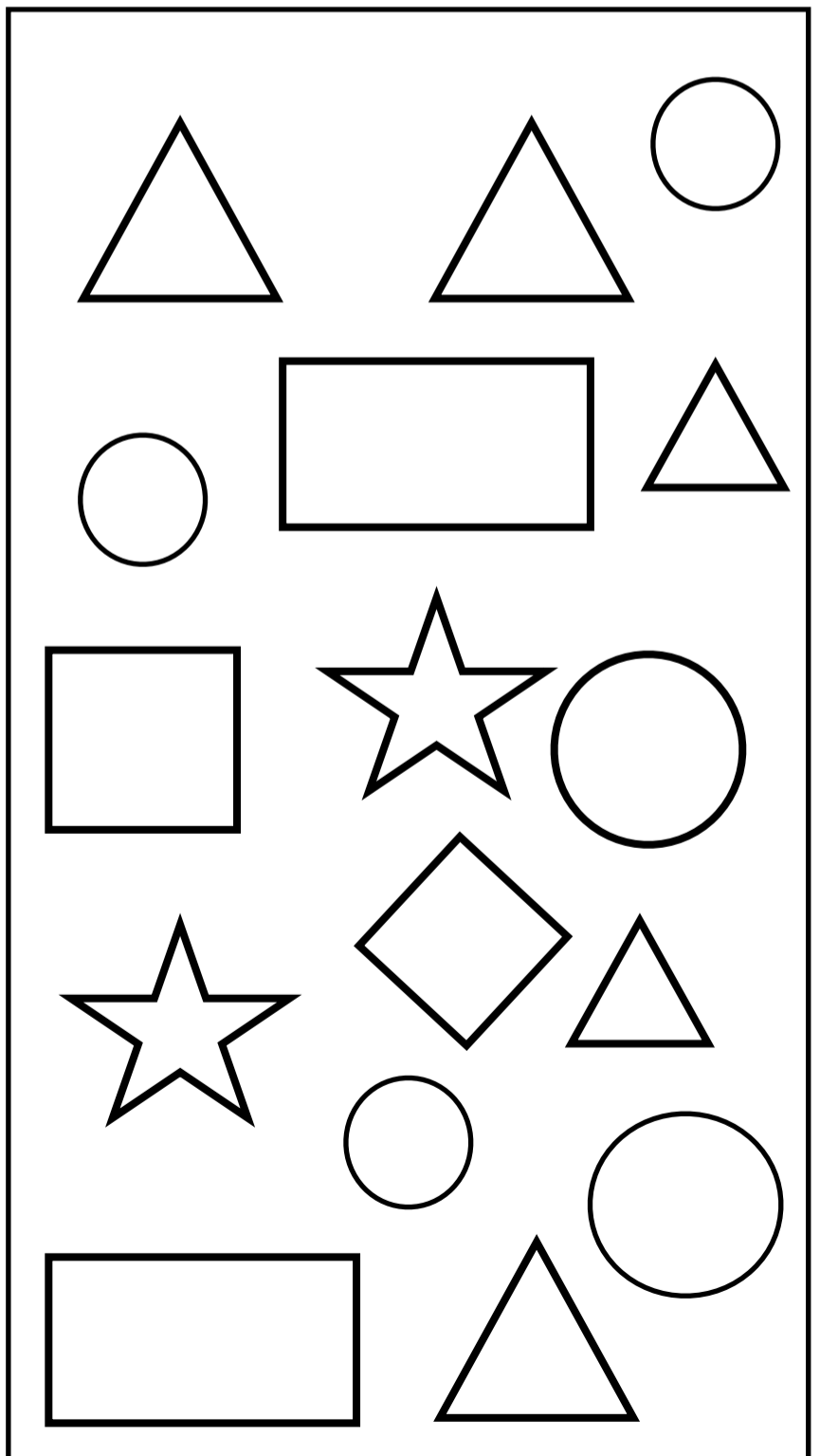

Answer the questions:

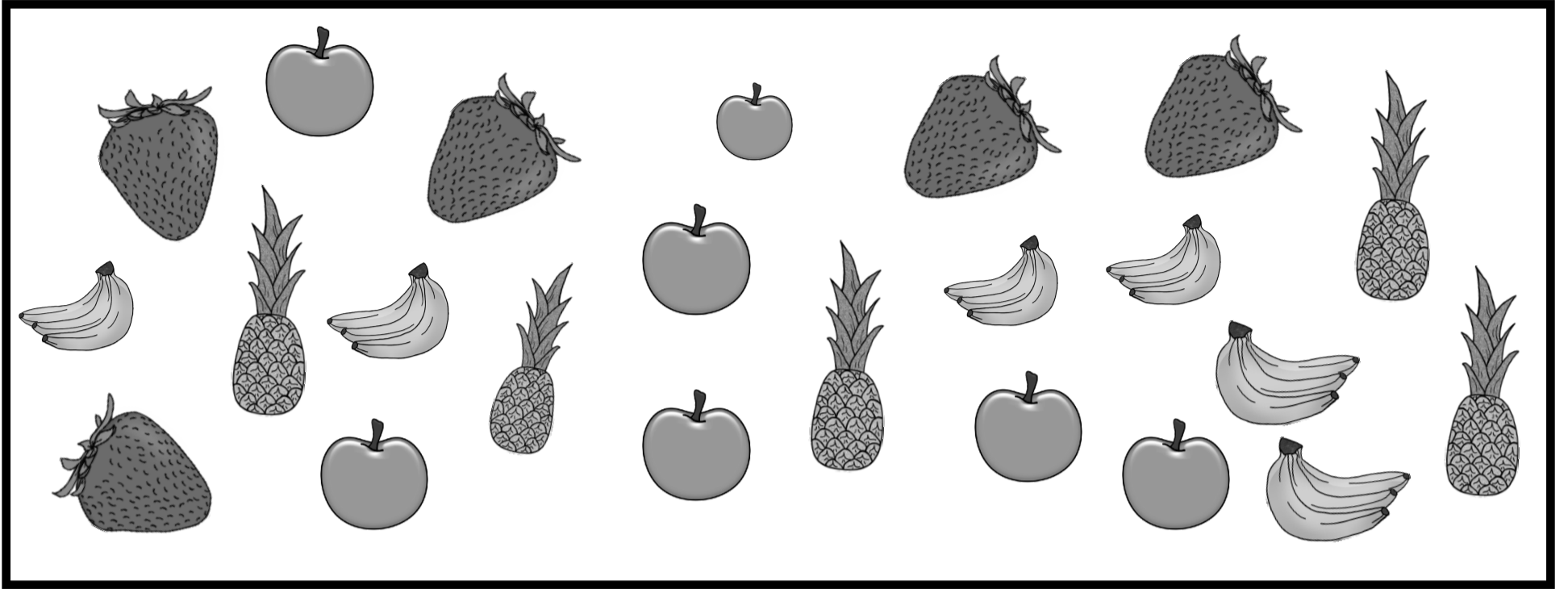

 1. How many apples are there? _____

 2. How many strawberries are there? _____

 3. How many pineapples are there? _____

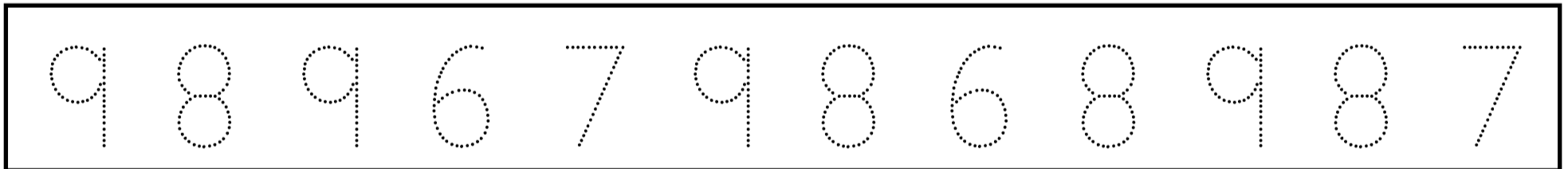

Color the items that are a rectangle: 

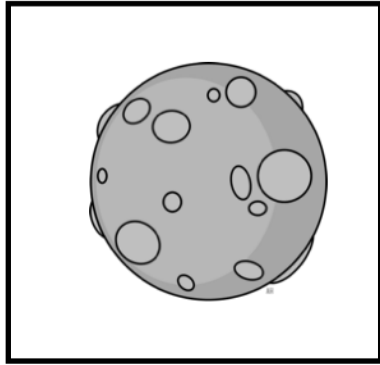
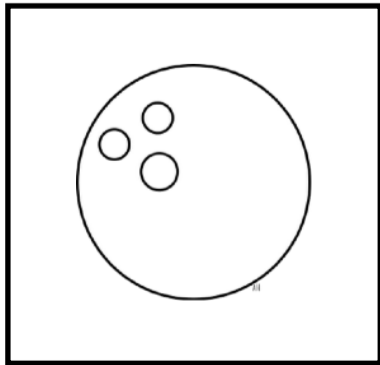
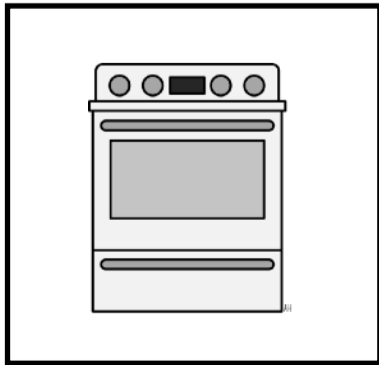
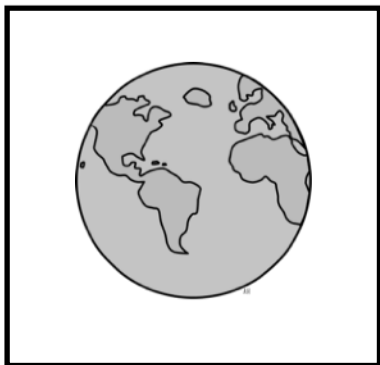
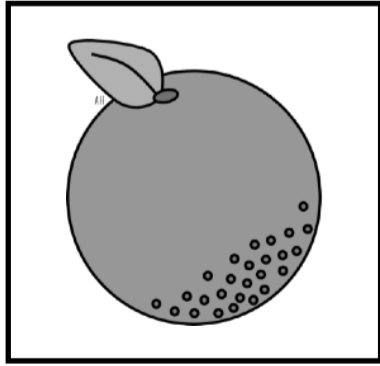
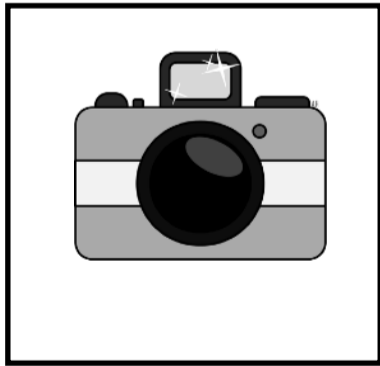
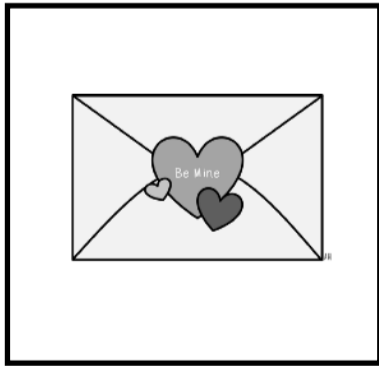
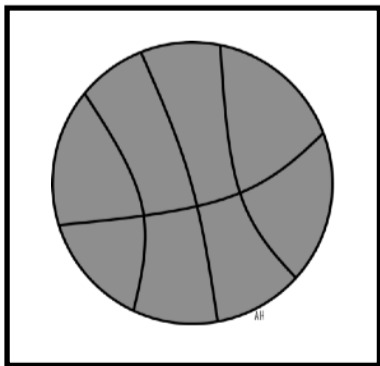

Find the numbers:

6	3	4	7	2	3	4	7	6	3	6
6	6	3	2	5	4	7	2	3	6	5
7	6	3	6	6	5	6	2	7	3	4
5	7	3	2	6	5	4	6	6	6	5
7	6	2	3	5	4	7	2	3	6	5
4	7	6	2	3	6	6	6	5	2	3
7	4	6	5	7	6	2	3	5	4	7
6	6	6	5	3	2	7	6	4	5	3
7	6	2	5	4	7	6	2	3	5	6

Circle all of: **6**

Find the numbers:

7	6	4	3	8	7	7	7	8	6	3
2	4	8	7	6	3	2	7	7	7	7
8	6	2	3	4	8	7	3	2	7	7
7	6	7	2	3	4	7	6	2	8	7
6	4	2	8	7	3	6	9	8	7	3
7	7	7	6	2	3	4	8	7	2	3
6	4	7	8	7	7	6	7	8	2	3
4	6	7	7	7	6	7	8	7	6	2
8	3	4	7	6	8	7	7	1	2	1

Circle all of: **7**

Circle the ones that are big:

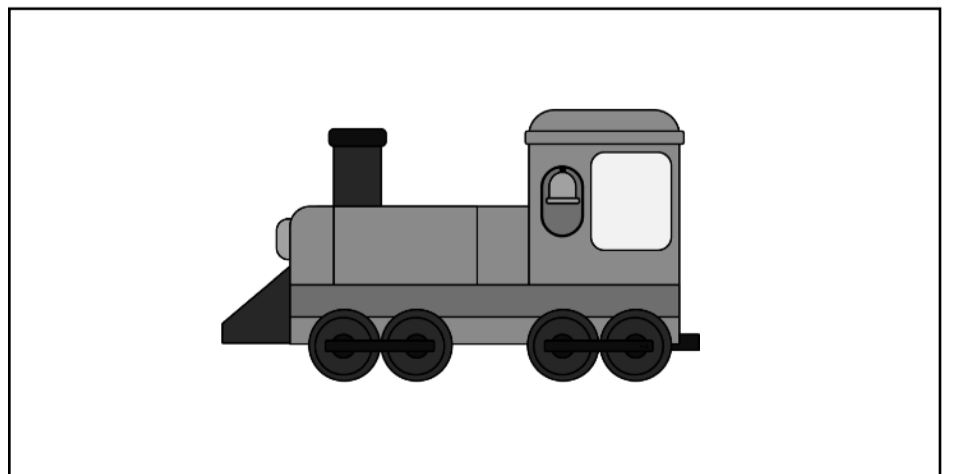
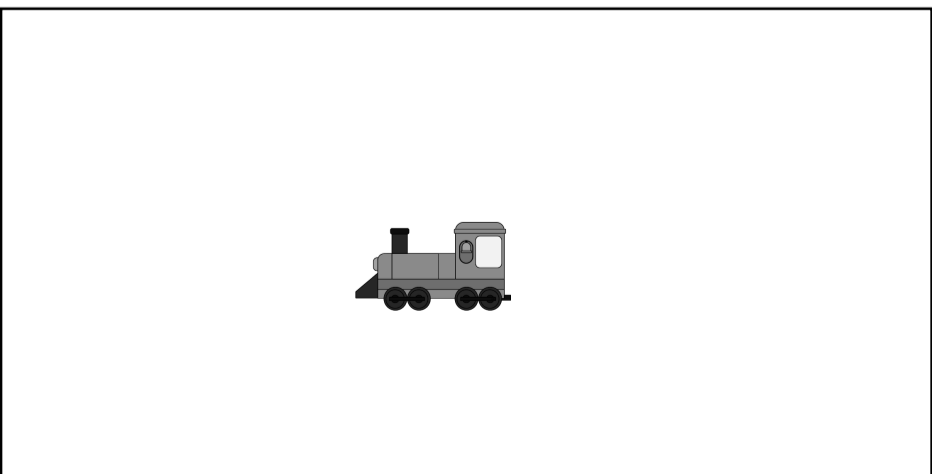
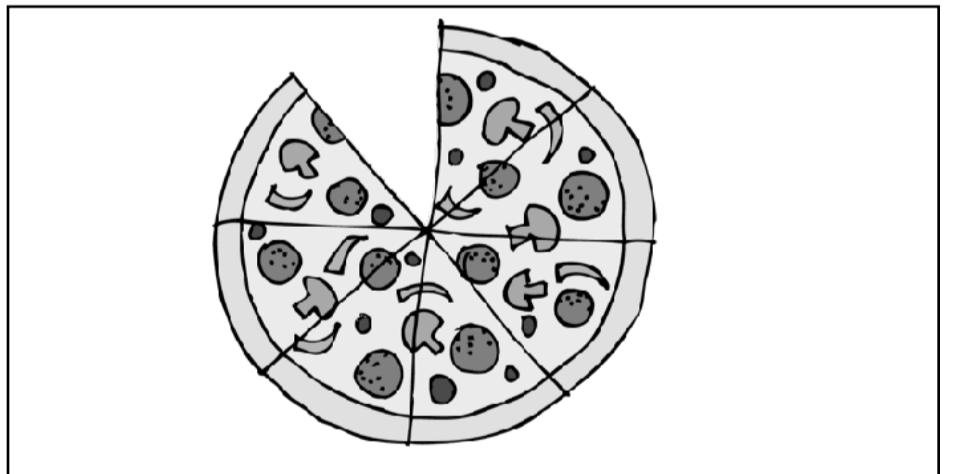
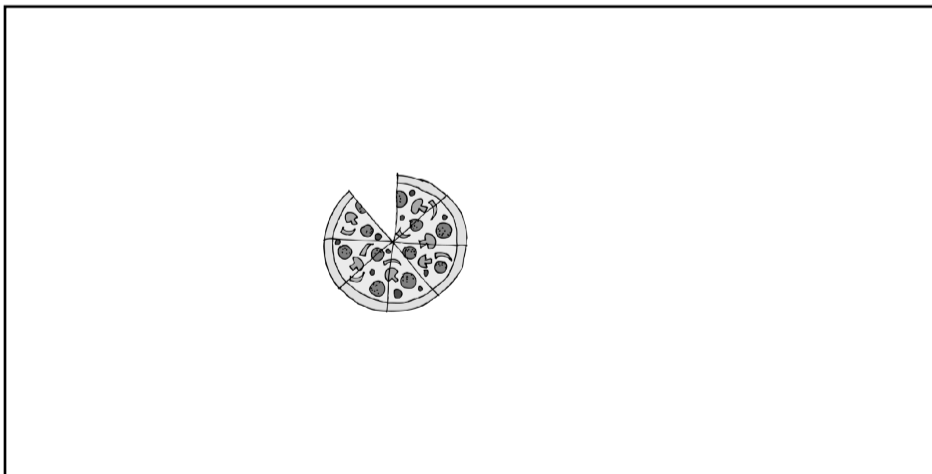
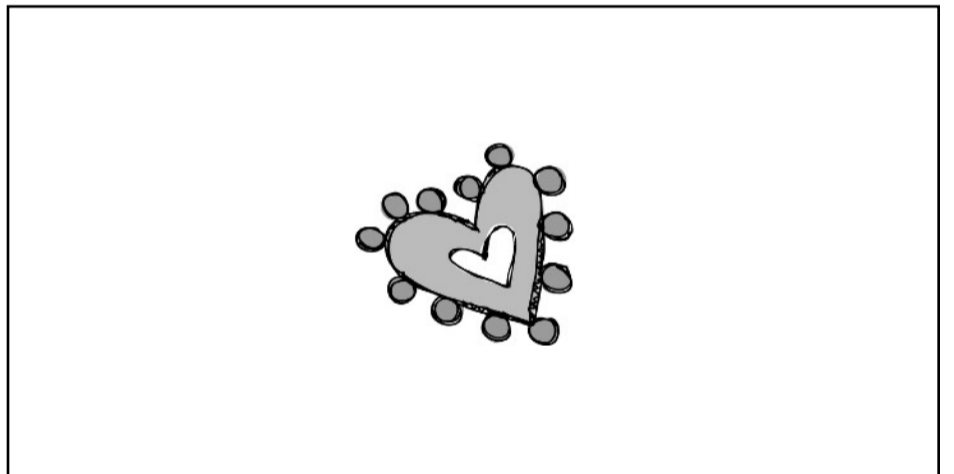
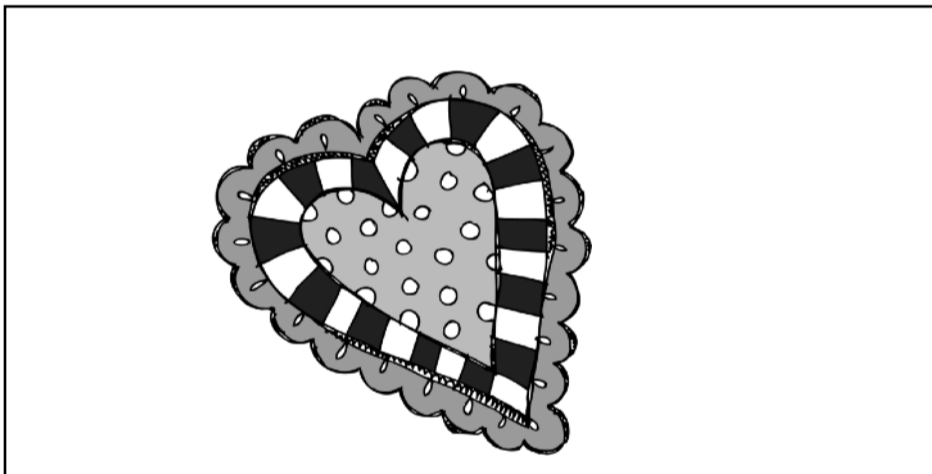

Answer the questions:

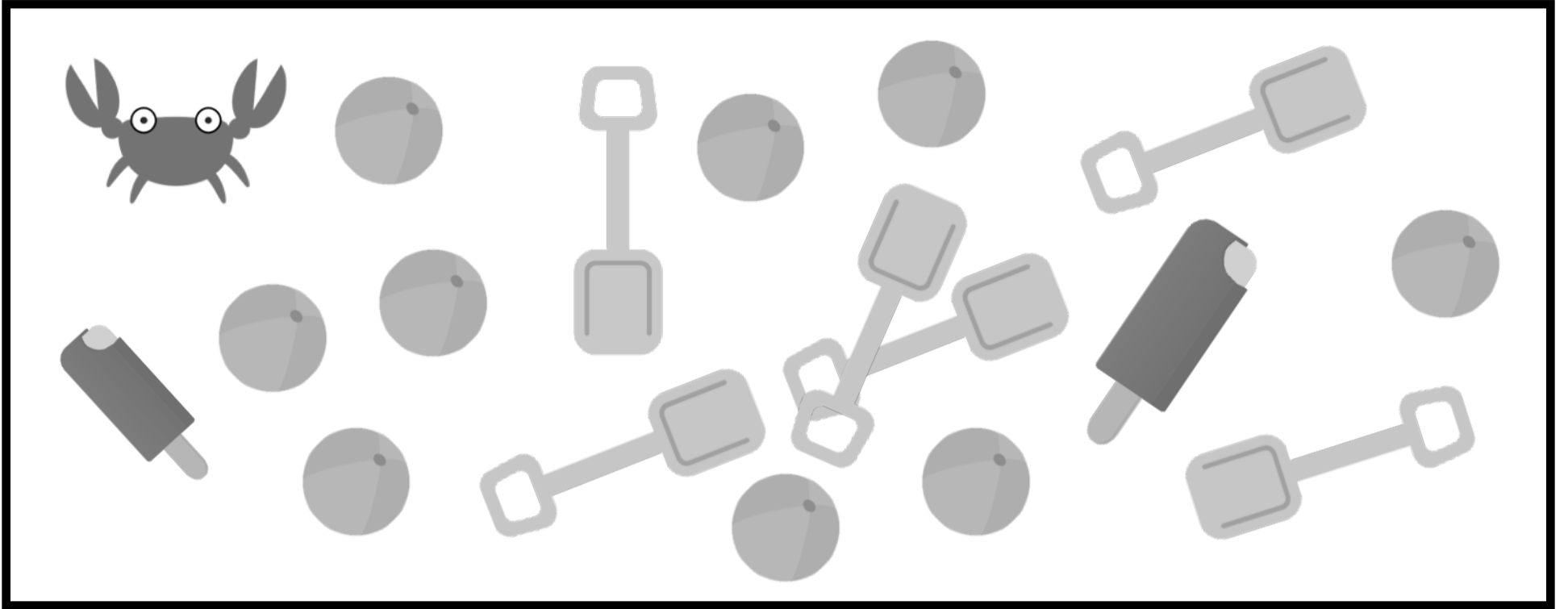

 1. How many balls are there? _____

 2. How many shovels are there? _____

 3. How many ice cream bars are there? _____

Match:

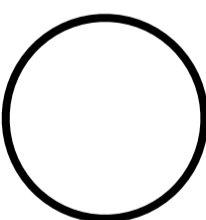

star

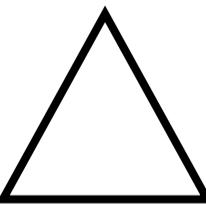

circle

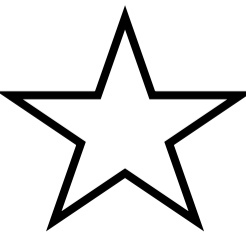

triangle

How many?

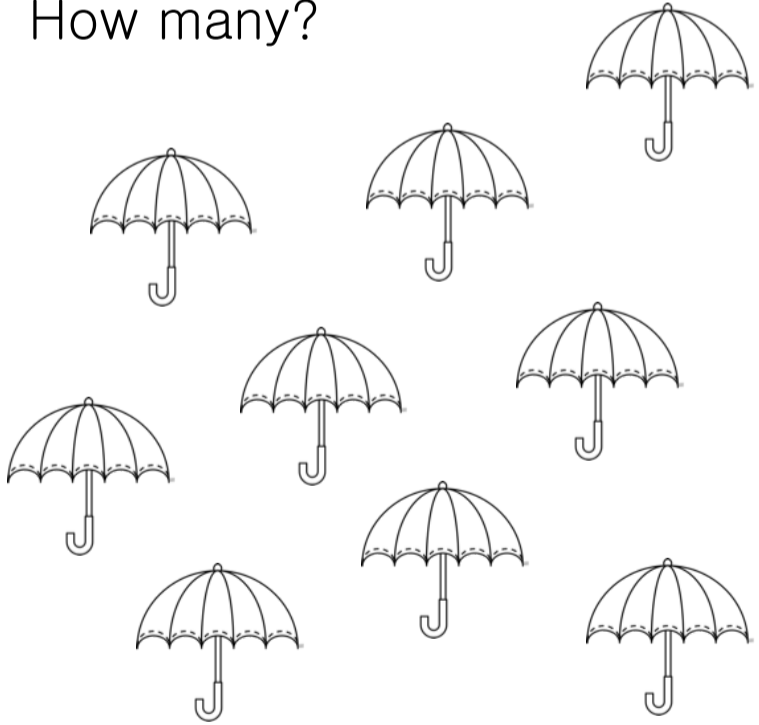

8 9 10

Circle the items that are big:

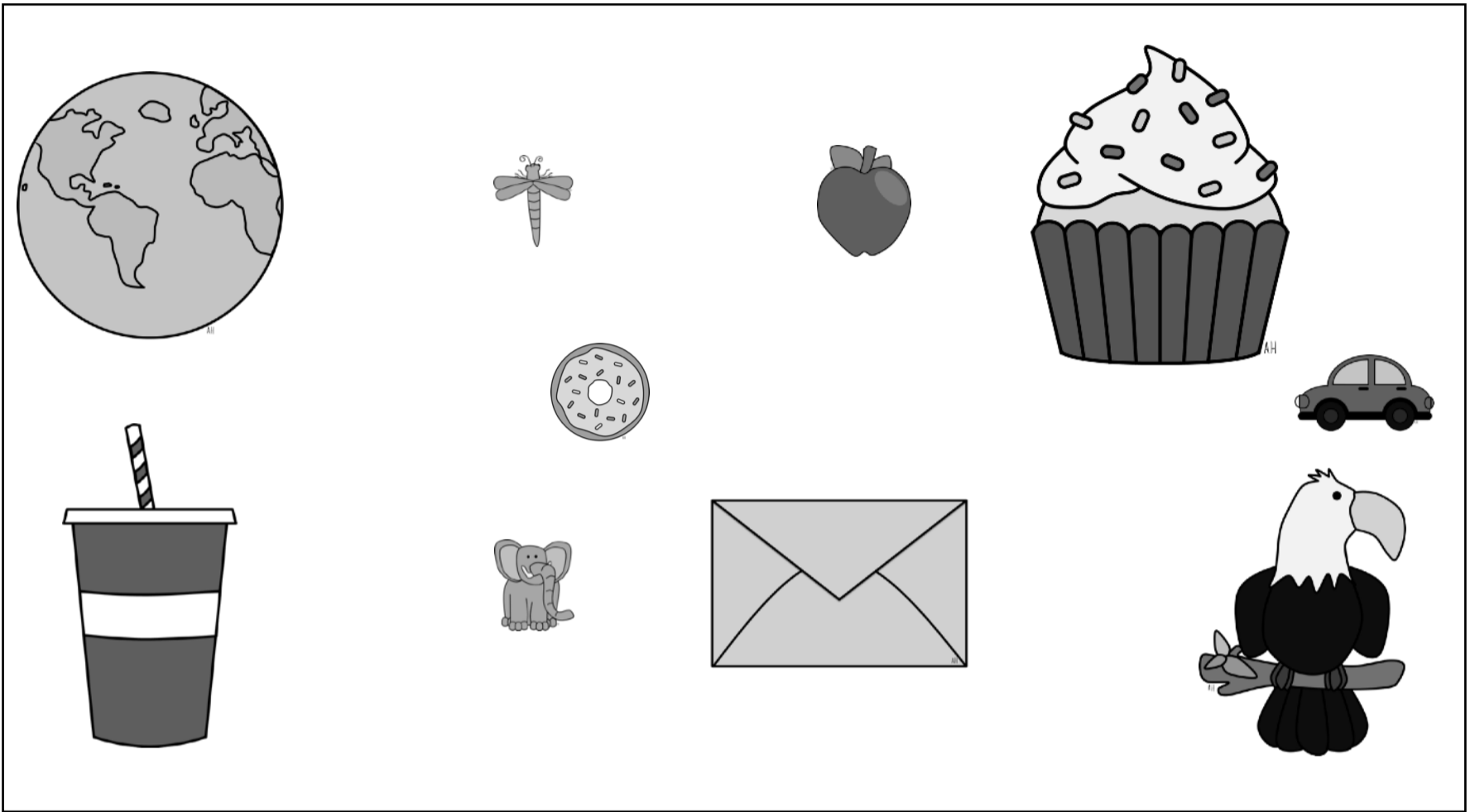
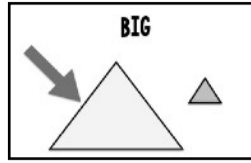

Practice writing the numbers:

7

9

Circle the one that is bigger:

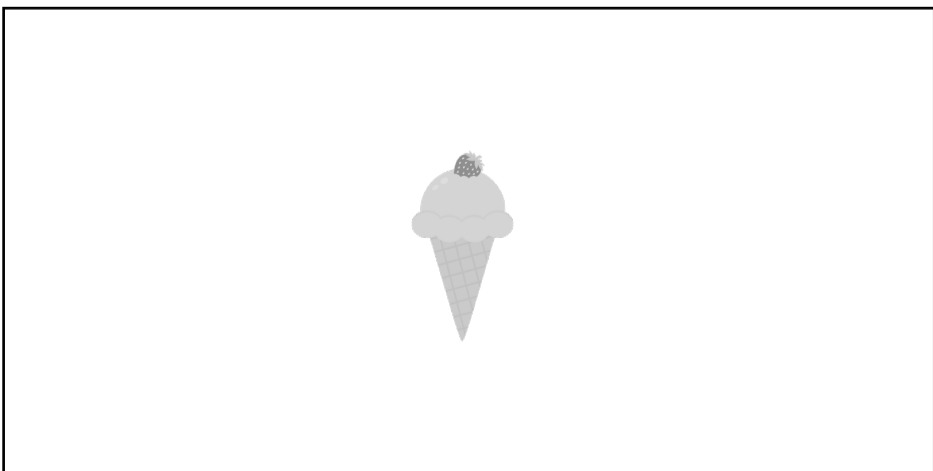

Match the numbers:

7

10

10

8

8

7

Count and Match:

1



2



3



4



5



Count and Match:

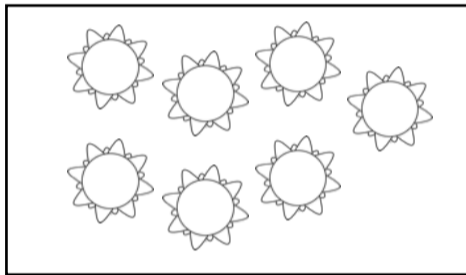

6

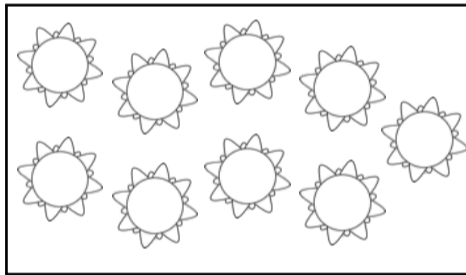

7

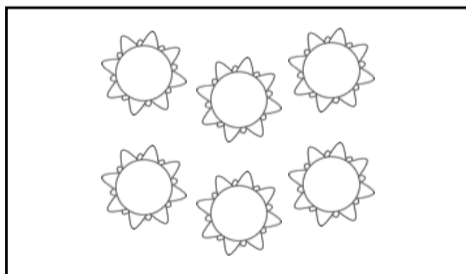

8

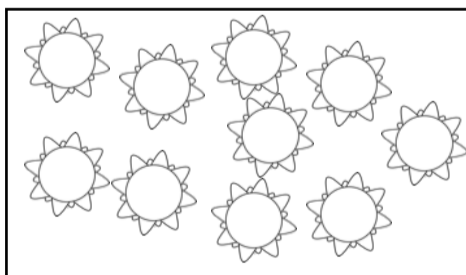

9

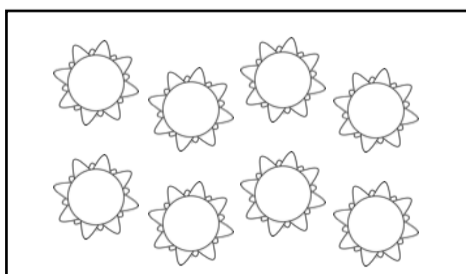

10

Color the ones that are BIG:

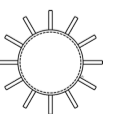
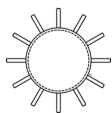
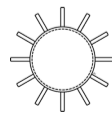
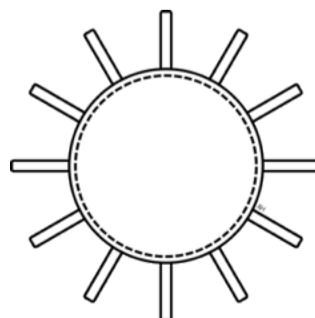
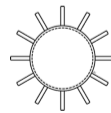
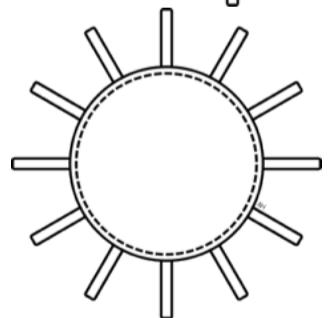
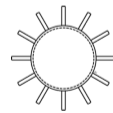
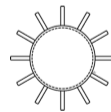
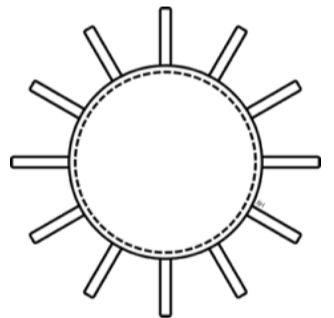
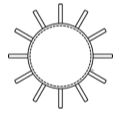
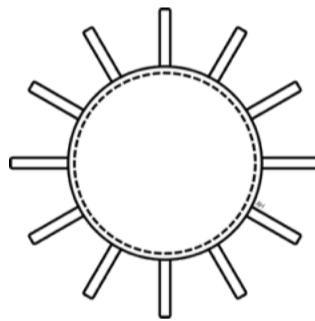

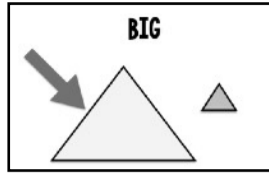

Circle the items that are big:

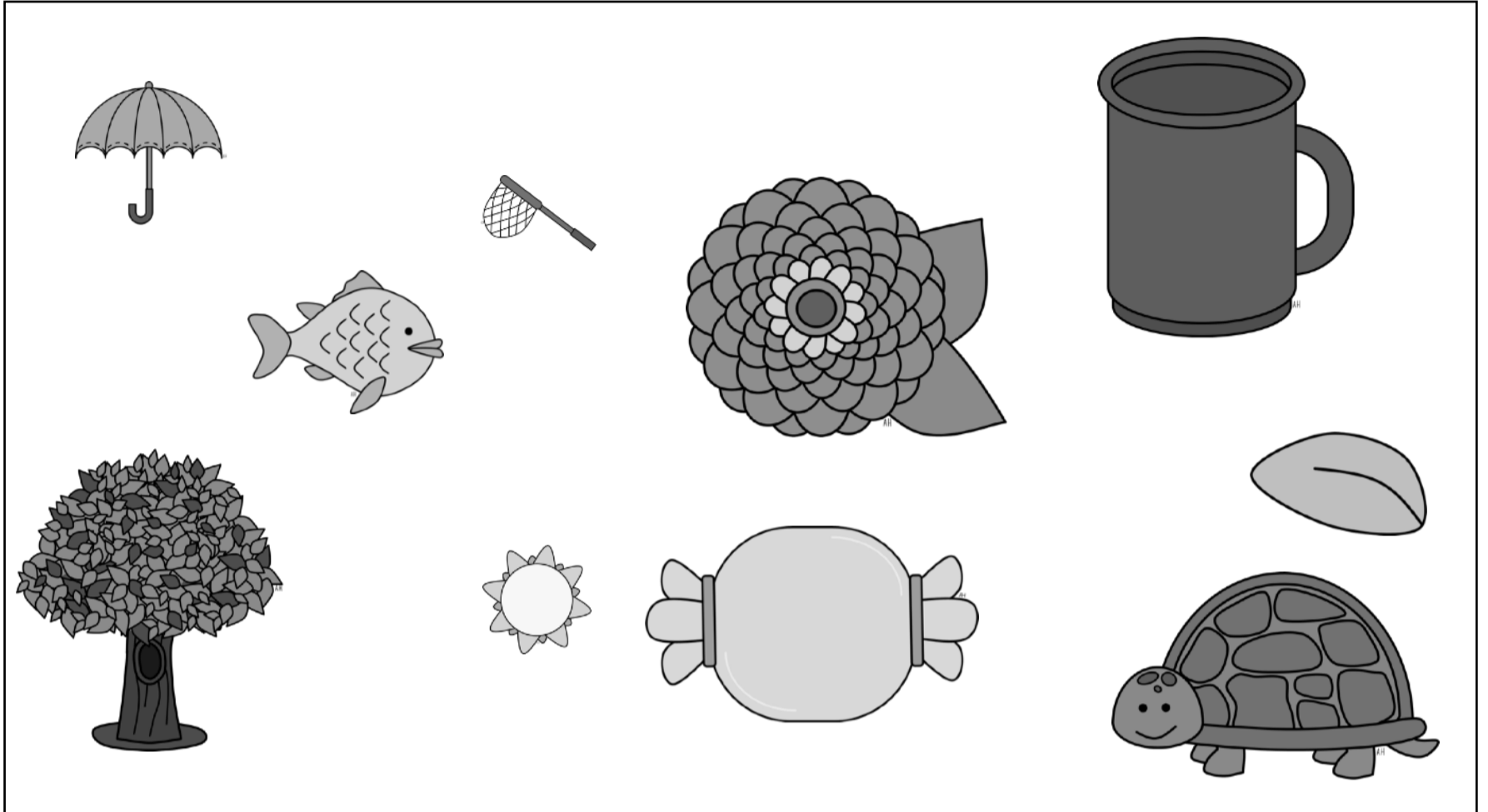

Circle the correct number of items:

	<input type="text" value="2"/>	<input type="text" value="3"/>
	<input type="text" value="2"/>	<input type="text" value="3"/>
	<input type="text" value="4"/>	<input type="text" value="3"/>
	<input type="text" value="4"/>	<input type="text" value="5"/>
	<input type="text" value="2"/>	<input type="text" value="1"/>

Find the numbers:

9	8	3	4	9	0	5	8	7	1
0	9	8	2	6	7	0	9	8	7
6	0	9	8	0	8	7	5	4	0
6	9	9	9	9	8	7	4	3	2
5	0	8	6	5	0	9	8	3	2
4	7	0	9	6	8	3	2	4	9
8	5	9	9	8	6	0	9	3	4
9	9	9	6	3	4	0	9	5	6
0	8	3	4	6	5	0	3	9	4
6	5	0	9	3	4	8	9	9	9
6	0	9	3	4	6	5	0	2	4
3	8	6	5	9	3	4	8	6	5
0	3	7	6	4	5	0	6	3	4
9 0 5 6 9									

Circle all of:

Write the numbers:

10		8		6		7	
9		10		8		9	
7		6		10		8	

Circle the ones that are big:

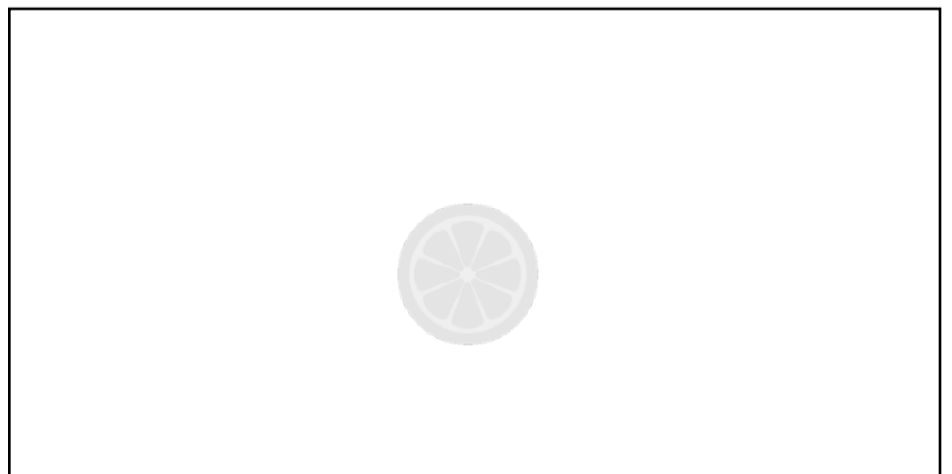
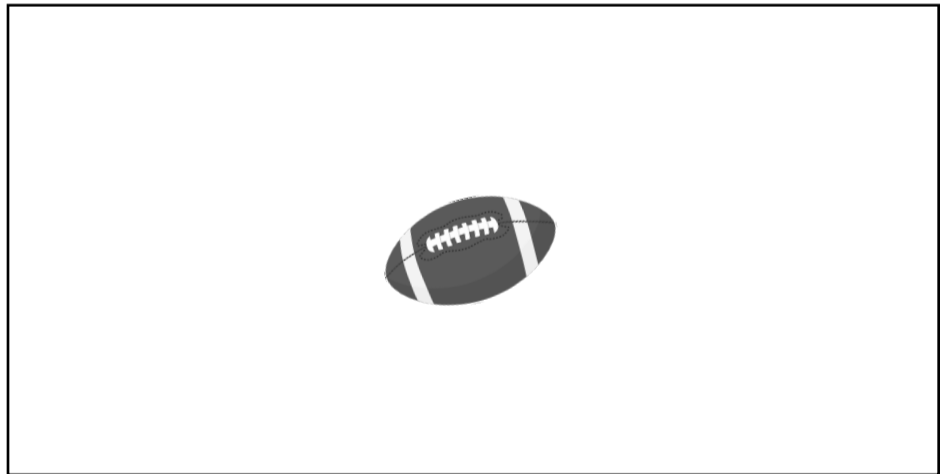
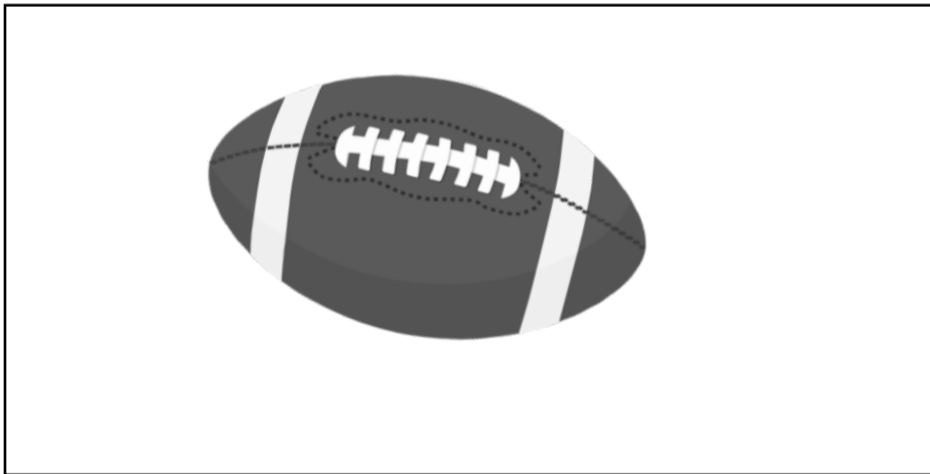
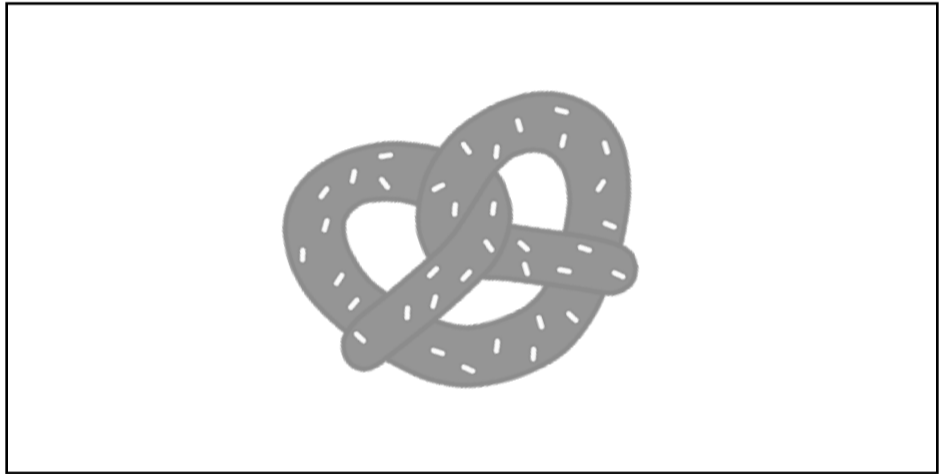
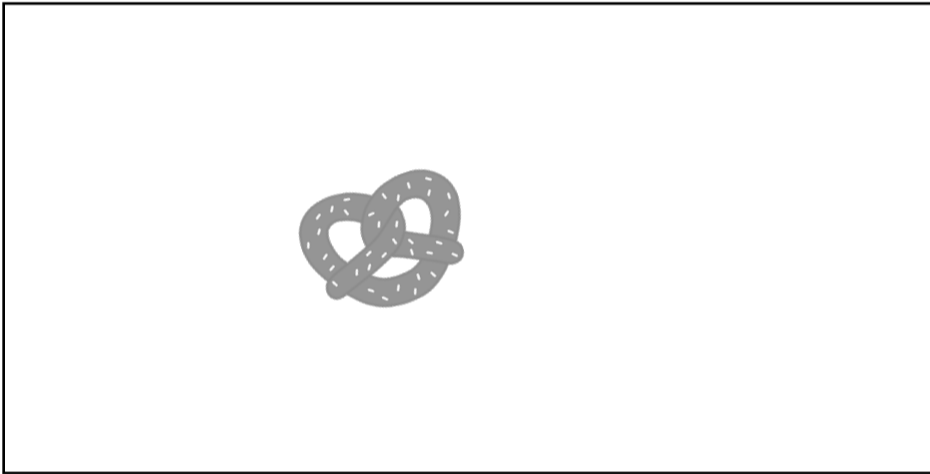

Find the numbers:

9	9	8	3	4	9	8	2	7	1	9
9	4	3	8	6	7	9	0	3	6	7
9	5	4	9	9	9	8	3	4	7	6
9	3	4	6	9	9	9	8	7	9	3
4	5	9	9	4	3	9	8	7	3	5
9	9	9	9	8	7	9	3	4	5	9
8	7	1	0	9	8	7	3	4	1	5
8	2	3	4	0	5	3	1	9	4	9
9	9	8	7	3	4	5	0	9	7	9

Circle all of: 9

Find the numbers:

6	6	4	8	7	3	6	5	8	7	0
6	0	2	7	3	6	1	5	8	7	6
4	3	7	8	5	6	0	7	4	6	5
0	7	8	3	4	2	6	5	7	8	0
6	6	6	6	7	8	0	2	3	6	4
0	8	7	3	6	5	8	7	6	8	7
3	4	6	5	8	7	3	4	6	5	0
7	8	6	6	6	7	6	0	8	7	6
8	7	6	6	6	6	6	8	7	8	8



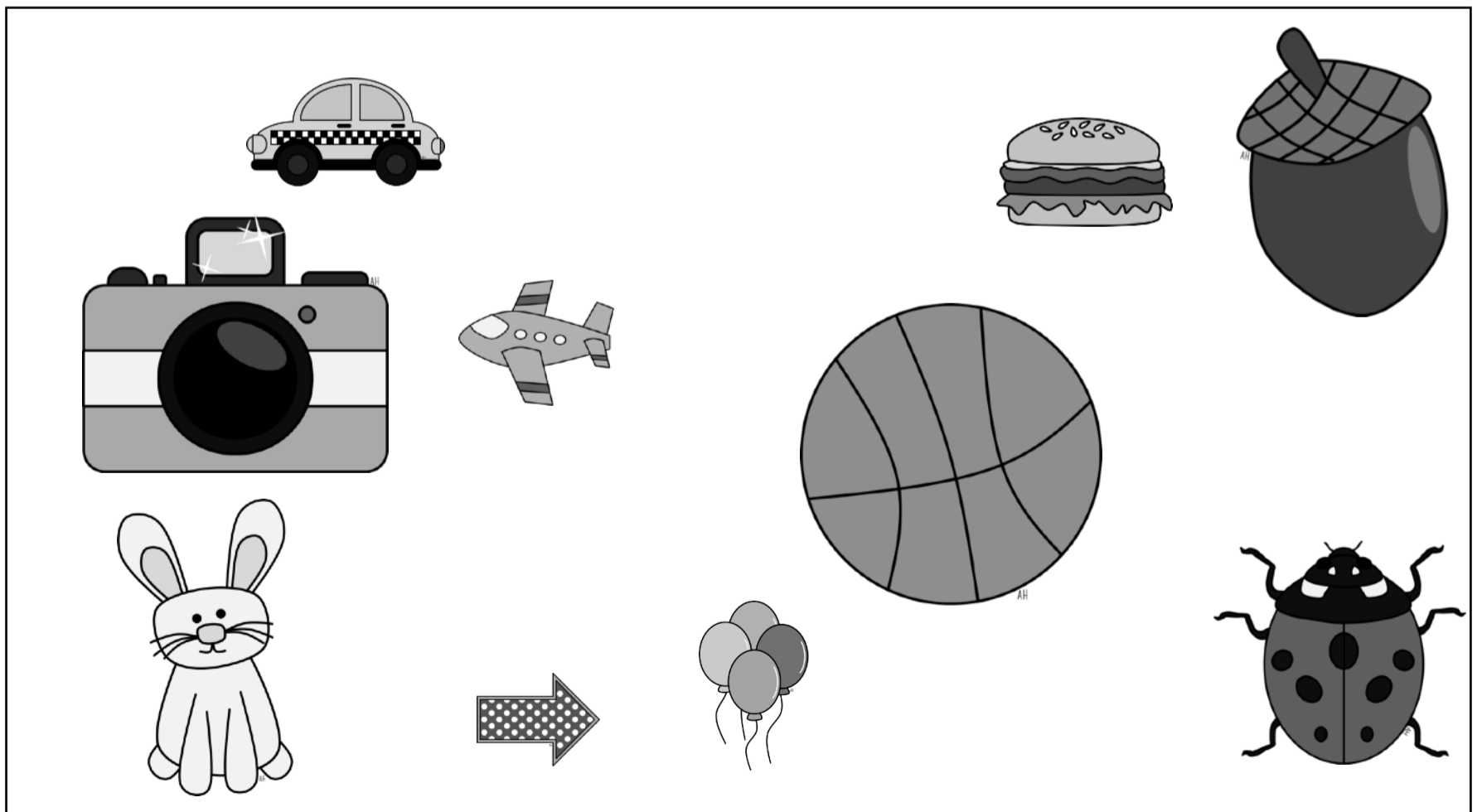
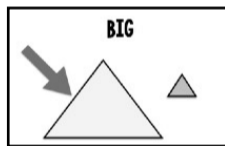

Circle all of: 6

7 8 9 6 8 7 8 9 6





Circle the items that are big:



Count and Match:

1	
2	
3	
4	
5	

Circle the correct number of items:

	3	4
	1	5
	5	4
	2	3
	4	3

Color the ones that are BIG:



Circle the one that BIG:

